

# ReThink office culture



PRODUCT CATALOGUE



**Cascando®**

CASCANDO P. 4

Our brand

Designers

SOUND ABSORPTION P. 336

3D AND OFML DATA P. 340

PROJECTS P. 344

FABRICS P. 346

PRODUCT INDEX P. 382

SALES & CONTACT P. 390



SPACE DIVIDERS P. 26

ACOUSTIC PANELS P. 80

Wall panels

Desk panels

Ceiling panels

SEATING P. 104

Poufs

Stools

Benches

Sofa's

TABLES P. 148

WARDROBE P. 178

Coat stands

Coat racks

Coat hooks

Coat hangers

DISPLAY AND STORAGE

P. 252

Mobile

Wall mounted

VIDEO FURNITURE P. 278

WHITEBOARDS P. 286

Mobile

Wall mounted

PLANTERS P. 306

UMBRELLA STANDS P. 320

PAPER BINS P. 328



# Why we should really think about office culture.

VALUE THE EFFORTS OF PEOPLE WITH AN ENJOYABLE WORK ENVIRONMENT THAT IMPROVES THE QUALITY OF WORK AND INCREASES JOB SATISFACTION.



The work we do says something about who we are. It colours our existence. We want to be productive, realise goals, and create progress – for ourselves and the organisations we work for. It is why we set our alarm clocks and wait for the bus to come early in the morning. Work nurtures us. It gives meaning and connects us to a bigger picture. It lets us grow, as a person and professionally.

## EXPERIENCING POSITIVITY

An inspiring, well-functioning work environment is paramount to ensuring that successful people can continue to be successful. A pleasant job and workplace drive an engaged, positive culture that fuels ambitions, invites, and connects. The quality of the jokes told at the lunch table is just as important as having a hook to hang up your coat or some privacy when your child's nursery is calling. Together, for and with each other.

WARUM WIR WIRKLICH ÜBER BÜROKULTUR NACH DENKEN SOLLTEN.

-  
Würdige den Einsatz von Menschen mit einem angenehmen Arbeitsumfeld, das die Qualität der Arbeit verbessert und die Arbeitsfreude erhöht.

Arbeit sagt etwas über uns aus, bringt Farbe in unser Leben. Wir möchten produktiv sein, Ziele erreichen und Fortschritt kreieren – für uns selbst und für die Firmen für die wir tätig sind. Darum stellen wir den Alarm ein und stehen Morgens früh bei der Bushaltee. Arbeit gibt uns Energie, ist bedeutungsvoll und verbindet uns mit dem grossen gemeinsamen Nenner. So kommen wir weiter. Als Mensch, und beruflich.

## POSITIVITÄT ERFAHREN

Um erfolgreiche Menschen bleibend erfolgreich sein zu lassen ist eine inspirierende, gut funktionierende Arbeitsumgebung eine Voraussetzung. Mit Freude arbeiten ist der Treibstoff für eine engagierte, positive Kultur die stimuliert, einladet und verbindet. Die Qualität des Scherzens am Mittagstisch ist dabei genauso wichtig wie ein freier Haken für deine Jacke an der Garderobe oder ein wenig Privacy wenn die Krippe anruft. Gemeinsam, für- und miteinander.



# How a positive office culture will allow people to move mountains.

DESIGN AN ENJOYABLE ATMOSPHERE WHICH CARRIES BOTH THE PLEASURE AND PERFORMANCE DNA.



Cascando believes that quality of work and enjoying your job are closely intertwined. Inclusivity; that's where it all starts. Finding pleasure in who you work with, where you work, and how you work ensures that the office feels like your clubhouse. Our designs are inspired by that vision. They are building blocks creating a positive culture where sharing, performances, and finding pleasure in work go hand in hand. Celebrate your workplace. Today. Or tomorrow.

## CONNECT AND GROW

Pleasure at the workplace stimulates finding pleasure in your work. It is this simple rule that we have adopted as our mantra. An inspiring interior motivates people as well as reflects and strengthens the company culture or identity. It invites people to collaborate and share ideas. And that leads to healthy growth, which will ultimately reflect in the overall results.

WIE EINE POSITIVE BÜROKULTUR MENSCHEN DEN WEG FREIMACHT UM BERGE ZU VERSETZEN.

-  
Kreiere eine angenehme Atmosphäre die beides beinhaltet; Vergnügens- und Leistungs- DNA.

Cascando ist davon überzeugt, dass die Qualität der Arbeit mit Freude zusammenhängt. Inklusivität; damit beginnt alles. Spaß haben mit wem du arbeitest, wo du arbeitest und wie du arbeitest, bewirkt, dass aus deinem Arbeitsplatz dein Clubhaus wird. Unsere Entwürfe sind durch diese Vision inspiriert. Sie sind Bausteine einer positiven Kultur, wobei teilen, leisten und Arbeitsfreude Hand in Hand gehen. Feier deinen Arbeitsplatz. Heute. Oder sonst Morgen.

## VERBINDEN UND WACHSEN

Spaß am Arbeitsplatz stimuliert Spaß an der Arbeit. Das ist ein einfaches Prinzip, das wir als Mantra führen. Eine inspirierende Einrichtung stimuliert Menschen, widerspiegelt und verstärkt die Betriebskultur oder Identität. Sie ladet ein zur Zusammenarbeit und zum Teilen von Ideen. Dies sorgt für gesundes Wachstum, einem Resultat dass unter dem Strich sichtbar wird.



# What we can do to improve the significance of our office culture.

CREATE AGILE INTERIOR PRODUCTS THAT BOOST TEAM SPIRIT AND PUT A SMILE ON YOUR FACE.



CASCANDO



WAS WIR MACHEN KÖNNEN UM DEN WERT UNSERER BÜROKULTUR ZU ERHÖHEN.

-  
Agiles Mobiliar einsetzen, das den Teamgeist stärkt und ein Lächeln auf das Gesicht zaubert.

Jede Arbeitsumgebung ist wie ein Mosaik, eine räumliche Figur, aufgebaut aus Elementen die gemeinsam eine Geschichte erzählen. Cascando widmet sich vollständig dieser Aufgabe. Unsere Kollektion Sitzsysteme, akustische Möbel und Accessoires werten den Raum auf, verbessern die Arbeit und kreieren Harmonie. Alles mit dem Ziel, mit Vertrauen an Herausforderungen von morgen heranzugehen. Optimistisch, mit einem Gefühl von Zusammengehörigkeit. Da es gemeinsam mehr Spaß macht.

## EIN LÄCHELN AUF DEINEM GESICHT

Eine schöne, praktisch eingerichtete Arbeitsumgebung bringt Zufriedenheit mit sich und lohnt sich gefeiert zu werden. Diese Mentalität formt die Basis unserer Designkollektion. Cascando möchte durchschnittliche Arbeitsplätze in inspirierende Arbeitswelten transformieren; durch Einrichtungslösungen, die verbinden, verbessern und Menschen neue Energie geben. Denn das ist, wo Cascando-Designs sich um drehen. Damit Menschen mit einem Lächeln auf ihrem Gesicht den Arbeitsplatz umarmen. Neugierig auf das, was der neue Arbeitstag ihnen bringt.

Every work environment is like a mosaic, a spatial figure put together with elements that, combined, tell a great story. Cascando is fully dedicated to realising that task. Our collection of seating elements, acoustic furniture, and accessories enhance the space, improve work activities, and create harmony – all with the single goal of meeting tomorrow's challenges with maximum confidence. Optimistic, born from a sense of community. Because being and working together is more fun.

## A SMILE ON YOUR FACE

A beautiful and practical work environment is satisfying and worth celebrating. Our design collection is based on that mentality. Cascando's goal is to transform regular workplaces into inspiring spaces by implementing interior solutions that connect, improve, and energise. That is what Cascando designs are all about. We make sure that people embrace their workplace, put a smile on their faces – curious to see what the new working day will bring.



Cascando®

# HOW CAN WE RETHINK THE ORDINARY AND EVOLVE THE OFFICE TO SOMETHING NEW?



CREATING AN ACTIVE CULTURE OF PROGRESS WITH INTERIOR SOLUTIONS THAT TRANSFORM GOOD TO GREAT.

How do you improve the experience and performance of people at their workplace in a world that is changing at lightspeed? At Cascando we are busy answering the questions that determine the future quality of the working environment. Designing positive, stimulating, and healthy workplace solutions is what drives us. Something you will recognize in the mentality of our employees and partners, in our collection and in the way our teams work. We bring an impulse. Always with the aim of energizing an informal and at the same time professional working environment. That is how we like it, that is how we deliver the best results, that is how we inspire the transformation from good to great. Open, involved, and progressive.

## OUR VALUES:

### TOGETHERNESS

We believe in the power of teamwork, are empathic. We have an eye for each other and feel committed to bloom everyone's talents and respect all motivations. Involvement that allows us to get the best out of ourselves and each other.

### PROGRESSIVE

Innovation is second nature to us. We present forward-thinking visions and enable our people and customers to evolve. We think in terms of opportunities and solutions, which makes us both enterprising and progressive.

### POSITIVE

We work from a positive mindset. We appreciate what goes well, are proud of great results and celebrate our successes. But we also constantly look at what we can do better. A constructive attitude, aiming to elevate good to great.

### OPEN

We are accessible, respectful and choose honesty and directness in communication with others. This clarity guarantees full transparency to our clients and partners. It allows us to progress. Together.

Wie verbessert man die Erfahrung und Leistung von Menschen an ihrem Arbeitsplatz in einer Welt, die sich mit Lichtgeschwindigkeit verändert? Bei Cascando beschäftigen wir uns intensiv mit der Beantwortung der Fragen, die die zukünftige Qualität der Arbeitswelt bestimmen. Das Entwerfen positiver, anregender und gesunder Arbeitsplatzlösungen ist unser Antrieb. Etwas, dass Sie an der Mentalität unserer Mitarbeiter und Partner, an unserer Kollektion und an der Arbeitsweise unserer Teams erkennen werden. Wir bringen einen Impuls. Immer mit dem Ziel, ein informelles und gleichzeitig professionelles Arbeitsumfeld zu beleben. So mögen wir es, so liefern wir die besten Ergebnisse, so inspirieren wir die Transformation vom Guten zum Großartigen. Offen, engagiert und fortschrittlich.

## UNSERE WERTE:

### ZUSAMMENGEHÖRIGKEIT

Wir glauben an die Kraft der Teamarbeit, sind empathisch. Wir haben ein Auge füreinander und fühlen uns verpflichtet, die Talente aller zu entfalten und alle Motivationen zu respektieren. Engagement, das es uns ermöglicht, das Beste aus uns und einander herauszuholen.

### PROGRESSIV

Innovieren ist für uns selbstverständlich. Wir präsentieren zukunftsorientierte Visionen und ermöglichen unseren Mitarbeitern und Kunden, sich weiterzuentwickeln. Wir denken in Chancen und Lösungen, was uns unternehmerisch und fortschrittlich macht.

### POSITIV

Wir arbeiten mit einer positiven Denkweise. Wir schätzen, was gut läuft, sind stolz auf tolle Ergebnisse und feiern unsere Erfolge. Aber wir schauen auch ständig, was wir besser machen können. Eine konstruktive Haltung, mit dem Ziel, aus Gutem Großartiges zu machen.

### OFFEN

Wir sind zugänglich, respektvoll und wählen Ehrlichkeit und Direktheit in der Kommunikation mit anderen. Diese Klarheit garantiert unseren Kunden und Partnern volle Transparenz. Es ermöglicht uns, Fortschritte zu machen. Gemeinsam.

# WHAT WE DO TO GUARANTEE A QUALITY CASCANDO EXPERIENCE EVERY STEP OF THE WAY?

WE GET THE BEST OUT OF OURSELVES AND DO EVERYTHING TO EXCEED YOUR EXPECTATIONS.

"Quality first" is our motto. There is a reason. At Cascando we are convinced that the quality of processes in our own organization is an important condition for creating perfect working environments for others.

That is why we work according to strict worldwide ISO guidelines (ISO 9001 and ISO 14001), we opt for responsible use of materials, and we make our 3D design data available via pCon. They are essential parts in our client-oriented organization, in an operation that has been guaranteeing beautiful interior products and global service excellence since 1998. It's simple, to us only the best is good enough: a reliable guarantee for fine design products that allow for a great workplace experience and inspire happiness at work.

„Qualität zuerst“ ist unser Motto. Es gibt einen Grund. Wir bei Cascando sind davon überzeugt, dass die Qualität der Prozesse in unserer eigenen Organisation eine wichtige Voraussetzung dafür ist, für andere perfekte Arbeitsumgebungen zu schaffen.

Deshalb arbeiten wir nach strengen weltweiten ISO-Richtlinien (ISO 9001 und ISO 14001), setzen auf einen verantwortungsvollen Umgang mit Materialien und stellen unsere 3D-Konstruktionsdaten über pCon zur Verfügung. Sie sind wesentliche Bestandteile unserer kundenorientierten Organisation, in einem Betrieb, der seit 1998 schöne Einrichtungsprodukte und weltweite Servicequalität garantiert. Ganz einfach: Für uns ist nur das Beste gut genug: eine verlässliche Garantie für hochwertige Designprodukte, die ein großartiges Arbeitsplatzerlebnis ermöglichen und zu Freude bei der Arbeit inspirieren.





## HOW WE MAKE CERTAIN OUR OPERATION HAS LITTLE ENVIRONMENTAL IMPACT?



WE ARE AWARE OF THE IMPACT OUR COMPANY HAS ON  
THE ENVIRONMENT AND THEREFORE ACT RESPONSIBLY.



Cascando verhält sich sozial verantwortlich. Wir legen größten Wert darauf, unsere Auswirkungen auf die Umwelt zu reduzieren. Genauer gesagt steht „Nachhaltigkeit“ im Mittelpunkt unserer Vorgehensweise. Wir produzieren nicht nur unsere komplette Kollektion in den Niederlanden, sondern wählen auch recycelte Rohstoffe in unseren Design- und Verpackungskonzepten, verwenden FSC-zertifiziertes Holz und beziehen unsere anderen Materialien, Komponenten und Rohstoffe von europäischen Lieferanten. Tatsächlich beziehen wir über 95 % dieser Materialien in einem Umkreis von 200 Kilometern um unsere Produktionsstätte in Duiven. So halten wir unseren CO<sub>2</sub>-Fußabdruck so gering wie möglich. Gut für uns selbst und für zukünftige Generationen.

Cascando behaves in a socially responsible manner. We take the greatest care in reducing our impact on the environment. More precisely, 'sustainability' is at the heart of our modus operandi. Not only do we produce our complete collection in the Netherlands, but we also choose recycled raw materials in our design and packaging concepts, use FSC-certified wood and source our other materials, components, and raw materials from European suppliers. In fact, we source over 95% of these materials within a radius of 200 kilometers around our production facility in Duiven. In this way we keep our CO<sub>2</sub> footprint as small as possible. Good for ourselves and for future generations.



# Designers

## SHARING A PHILOSOPHY TO CREATE TIMELESS AND ORIGINAL DESIGNS

The Cascando collection is created in close collaboration with a talented group of international designers. Their inspiring visions and original design ideas are a springboard for developing pleasurable workspace products that put a smile on the user's face.

Die Cascando-Kollektion entsteht in enger Zusammenarbeit mit einer talentierten Gruppe internationaler Designer. Ihre inspirierenden Visionen und originellen Designideen sind ein Sprungbrett für die Entwicklung angenehmer Arbeitsplatzprodukte, die ein Lächeln auf das Gesicht des Benutzers zaubern.



## PETER VAN DE WATER

Furniture & interior designer

Graduated from the Artschool St. Joost in Architecture & Spatial design. 'Intelligent simplicity' is typical for his furniture designs. His development is shown in his designs for Cascando: from minimalist (like the U2 tables) to more playful, but always looking for that one perfect durable solution to combine aesthetics, function and construction.

Graduierte von der Artschool St. Joost in Architektur und Raumgestaltung. Typisch für sein Design ist die intelligente Einfachheit. Seine Entwicklung wird in seinen Entwürfen für Cascando gezeigt: Von minimalistisch (wie die U2-Tischen) zu mehr spielerisch, aber immer auf der Suche nach der perfekten dauerhaften Lösung wo Ästhetik, Funktion und Konstruktion zusammenkommen.



## ROBERT BRONWASSER

Designer & art director

Graduated with distinction as an Industrial Designer from Delft University in 1992. He passionately merges creative skills, commonsense and 25 years' experience into useful designs with a one-off look - to put a daily smile on your face.

Bronwasser hat sein Studium an der Technischen Universität Delft 1992 „cum laude“ abgeschlossen. Heute ist er ein Industriedesigner, der mit Leidenschaft kreative Fertigkeiten, gesunden Menschenverstand und 25 Jahre Erfahrung miteinander verbindet, um einen einmaligen Look zu schaffen, der dem Betrachter jedes Mal aufs Neue ein Lächeln entlockt.

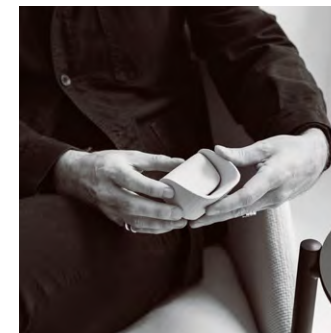

# EMILIANA ANA MIR & EMILI PADRÓS

Designers

They met during their MA in Industrial Design at the Central Saint Martins School in London. Their vision of design comes from experimentation and the prospect of new scenarios, where they pursue relations between objects and spaces. Spaces in which the user should be as participatory, moved and creative as possible.

Sie trafen sich während ihrer MA in Industrial Design an der Central Saint Martins School in London. Ihre Vision von Design stammt aus Experiment und der Aussicht auf neue Szenarien, in denen sie Beziehungen zwischen Objekten und Räumen suchen. Umgebungen in denen der Benutzer so teilnehmend, bewegt und kreativ wie möglich ist.



## MARLEEN VALSTAR

Designer & interior architect

Studied furniture design and architectural design at the Academy of Visual Arts in Maastricht. Since 1998, she has been working as a product designer and interior architect. "A product has to work, both in terms of design and function. Neither aspect is less important than the other".

Studierte Möbeldesign und Architektonische Gestaltung an der Akademie der Bildenden Künste in Maastricht. Arbeitet seit 1998 als Produktdesigner und Innenarchitekt. "Ein Entwurf muss stimmen, sowohl in der Gestaltung als auch in der Funktion. Keine von beiden spielt dabei eine untergeordnete Rolle."





## GERALD BRANDSTÄTTER

Interior architect & designer

Studied at the art school in Zurich and at the Art Center College of Design in Pasadena, U.S.A. In 1994, he established his design studio CONCEPT-B, where German rationalism and Italian elegance merge with Swiss precision. His designs for Cascando are „good designs geared towards people and their many different needs.“

Studierte an der Kunstschule in Zürich und am Art Center College von Design in Pasadena, USA. Im Jahr 1994 gründete er sein Designstudio KONZEPT-B, in dem der deutsche Rationalismus und die italienische Eleganz mit Schweizer Präzision verschmelzen. Seine Entwürfe für Cascando sind „gute Designs gegenüber den Menschen und ihren vielfältigen Bedürfnissen.“



## ONNO DE KNEGT

Designer & interior architect

Active since 1986 as an interior architect and project designer. His designs are characterised by peace and neutrality, both in material and color use. “I am a supporter of fair, tight and timeless designs that are broadly and sustainable usable for the user.”

Seit 1986 tätig als Architekt und Designer. Seine Entwürfe sind durch Frieden und Neutralität geprägt, sowohl in Material und Farbe. “Ich bin ein Anhänger von fairen, straffen und zeitlosen Designs, welche breit und nachhaltig nutzbar sind für den Benutzer.”



# Space dividers

CHANGE THE SCRIPT WITH MULTIFUNCTIONAL SPACE DIVIDERS THAT MAKE OPEN SPACE A TAD MORE PERSONAL.

Organising different user spaces without having to separate is a big yes. Just do it. Push, drive, and position. Easy on the eyes, sound absorbing. Agility assured.

Verschiedene Benutzerbereiche ohne fixe Trennung zu kreieren ist sehr willkommen. Probiere das einfach aus. Schieben, Fahren und Positionieren. Ein schöner Anblick, schallabsorbierend. Mobilität versichert.



Scan to discover  
Space dividers

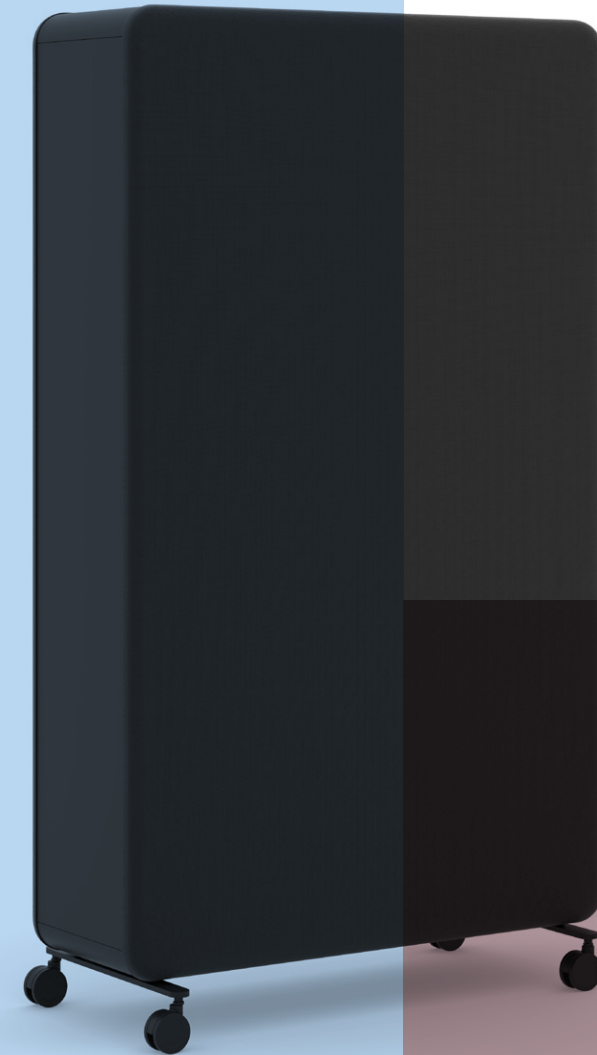

# Patio

DESIGN ROBERT BRONWASSER



# Patio

DESIGN ROBERT BRONWASSER

Open space becomes hybrid space. Patio is a range of space organizing elements, designed to increase the performance and well-being of teams and individuals. Patio will transform your open space into an intimate work-, relax- or collaboration space.

Das Großraumbüro wird zum hybriden Raum. Patio ist eine Reihe von Elementen zur Raumorganisation, die entwickelt wurde, um die Leistung und das Wohlbefinden von Teams und Mitarbeitern zu steigern. Patio verwandelt Ihr Großraumbüro in einen intimen Arbeits-, Entspannungs- oder Kollaborationsraum.

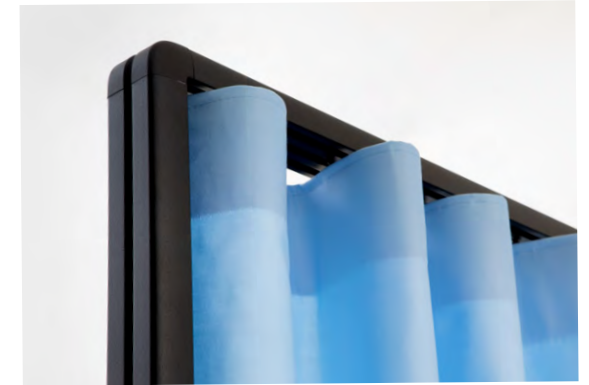



# Patio Single

DESIGN ROBERT BRONWASSER



Mobile, agile and highly functional. Equipped with upholstered and acoustic panels, whiteboards or video screens, Patio Single offers great productivity. The freestanding single elements are available in various widths.

Mobil, agil und hochfunktional. Ausgestattet mit gepolsterten und akustischen Paneelen, Whiteboards oder Videoscreens bietet Patio Single beste Produktivität. Die freistehenden Einzelelemente sind in verschiedenen Breiten erhältlich.



CASCANDO



# Patio Connect

DESIGN ROBERT BRONWASSER



Organizing the open space becomes easy with Patio Connect. With the fixed L-shape, Z-shape, U-shape and T-shape elements you can create multiple flexible spaces. On casters with brakes, they can be moved around easily. Because every day is different.

Organisieren eines Großraumbüros wird mit Patio Connect einfach. Mit den fixen Elementen in L-Form, Z-Form, U-Form und T-Form kann man mehrere flexible Räume kreieren. Auf Rollen mit Bremsen können sie einfach verschoben werden. Denn jeder Tag ist anders.



# Patio Fold

DESIGN ROBERT BRONWASSER



Huddle spaces, focus rooms or scrum areas pop up in a minute and can be stored away in seconds. Patio Fold elements can be folded together. They create space wherever necessary and save space when needed. Agile working has never been that easy.

Huddle Spaces, Focus Rooms oder Scrum Areas erscheinen in einer Minute und können in Sekunden verstaut werden. Patio Fold Elemente können einfach zusammengeklappt werden. Sie schaffen Platz, wo es nötig ist, und sparen Platz, wenn es nötig ist. Agiles Arbeiten war noch nie so einfach.



CASCANDO



# Patio Double

DESIGN ROBERT BRONWASSER





With Patio Double it becomes easy to store your personal belongings or office stuff. Equipped with upholstered panels or whiteboards, the elements offer great functionality. Having casters with brakes, they can easily be moved around through any space.

Mit Patio Double wird es einfach, persönliche Gegenstände oder Bürountensilien aufzubewahren. Ausgestattet mit gepolsterten Paneelen oder Whiteboards bieten die Elemente eine hohe Funktionalität. Auf Rollen mit Bremsen können sie leicht durch jeden Raum bewegt werden.







CASCANDO

MATERIAL AND FINISH

Powder coated aluminum frame, bar and coathooks, powder coated steel shelves, tray and brochure holder, magnetic steel whiteboard, with optional a strip of panel fabric, uni décor grey or oak

OPTIONS

Curtain, panel transparent, panel fabric, panels wood decor, panel acoustic, whiteboard, wardrobe, magazine holder, shelves, tray, planter, LCD-support, cabinet

FABRICS

See our wide range of fabrics in chapter Fabrics

ACOUSTIC PROPERTIES

Standard or premium, attenuation and absorption

COLOURS



DIMENSIONS

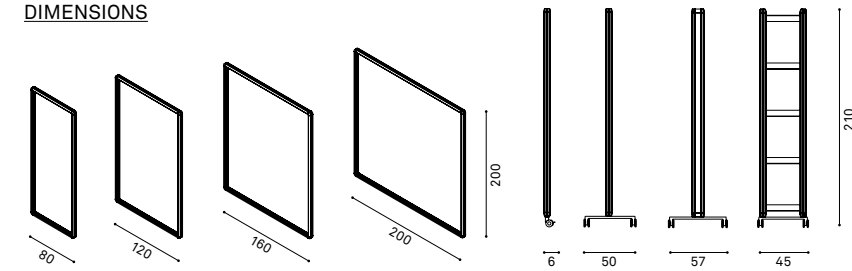

CONFIGURATIONS PATIO SINGLE AND CONNECT

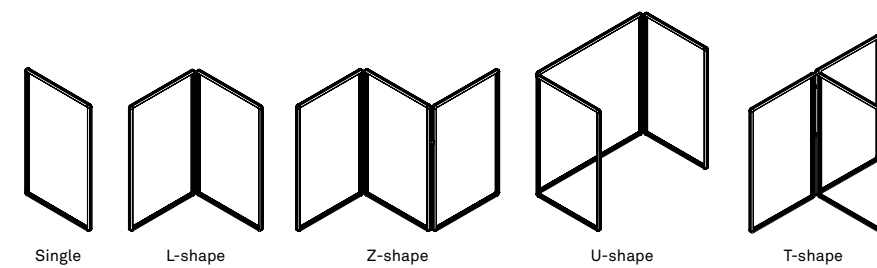

CONFIGURATIONS PATIO FOLD

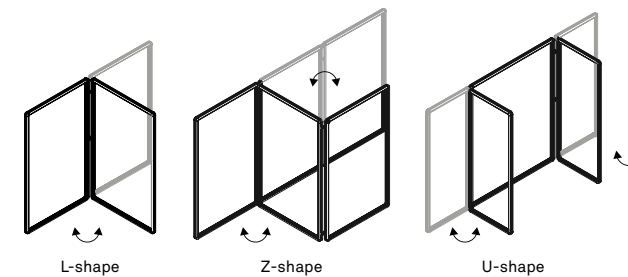

Upholstered panel

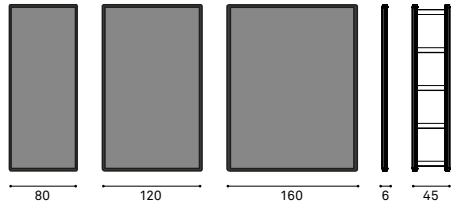

Acoustic panel - single or double sided upholstered

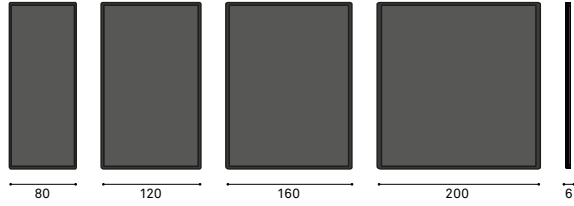

Oak decor panel

Uni grey panel

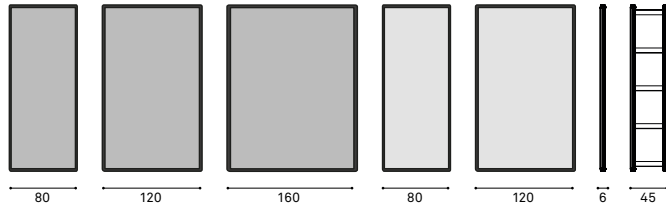

Acrylic glass panel

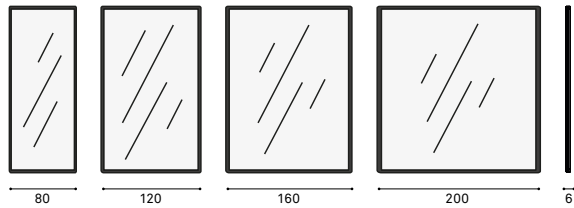

Curtains

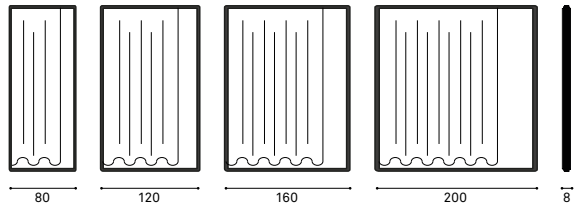

Whiteboard

Whiteboard + upholstered panel/decor panel

Whiteboard - open

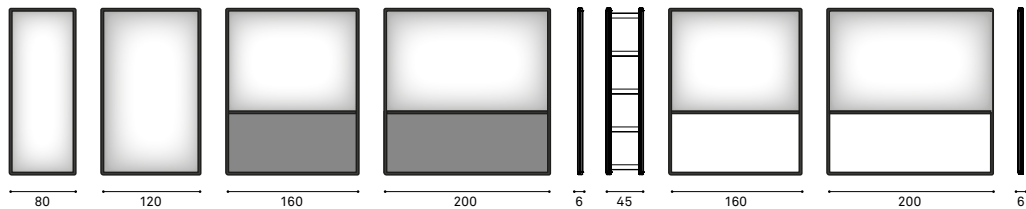

Screen support with upholstered panel

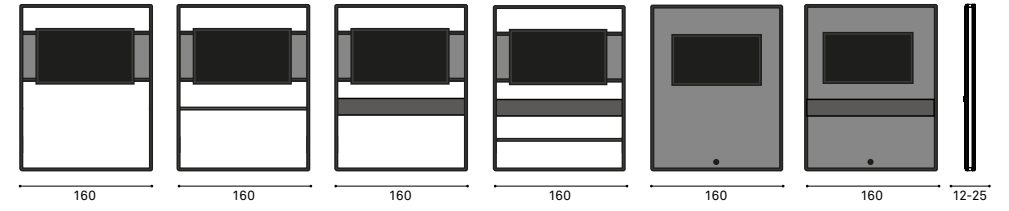

Magazine tray(s)

Magazine tray(s) - with upholstered panel

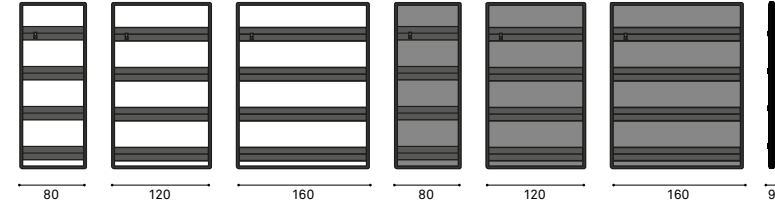

Shelves - depth 25 cm

Tray(s) - depth 12 cm

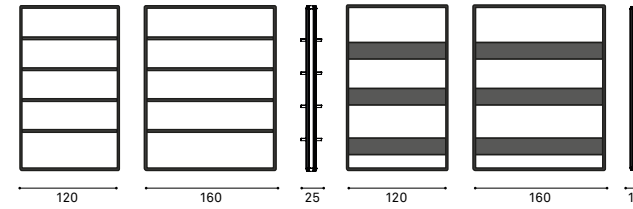

Shelves - depth 38 cm

Shelves with upholstered panel - depth 38 cm

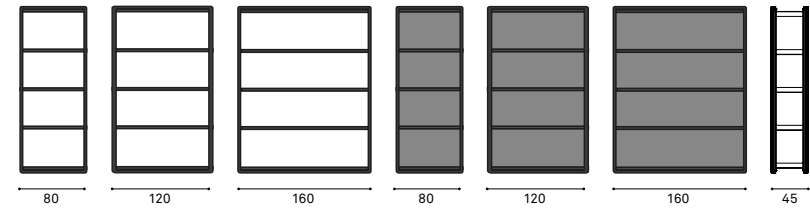

Wardrobe - for hangers or hooks

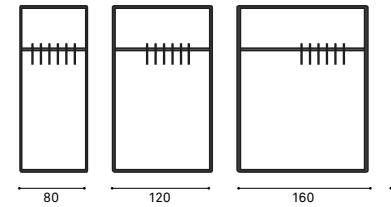

Cable for planters - adjustable

Planter tray(s)

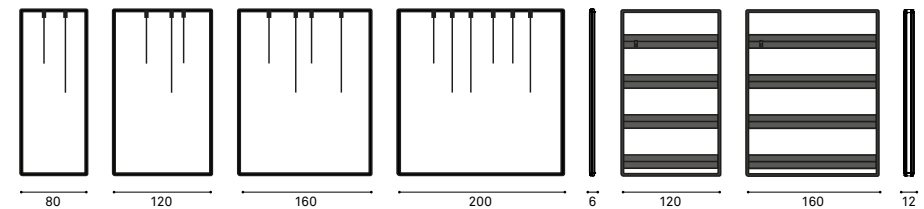

# Pillow Space

DESIGN ROBERT BRONWASSER





## Pillow Space

DESIGN ROBERT BRONWASSER

Pillow Space is a series of innovative space dividers with an unprecedented performance. They provide visual privacy, sound absorption and a high level of functionality to any open space. Standard or premium acoustic wool guarantees optimal sound absorption in any situation.

Pillow Space ist eine Reihe extrem leistungsfähiger, innovativer Raumteiler. In großräumigen Umgebungen dienen sie als Sichtschutz, Schallabsorber und Multifunktions-element. Die Wolle in Standard- oder Premium-Qualität garantiert, dass Geräusche in jeder Situation optimal absorbiert werden.



Equipped with casters and brakes, the elements are mobile and flexible. Whiteboards, LCD screens, coat hooks and brochure holders can be mounted on the outside. On the inside (in the space between the panels), shelves, displays, wardrobe, drawers, planters and lockers can be placed.

Rollen mit Bremsen verleihen den Elementen Mobilität und Flexibilität. Auf der Außenseite können die Paneele mit Whiteboards, LCD-Bildschirmen, Kleiderhaken und Prospekthaltern ausgestattet werden. Auf der Innenseite (zwischen den Paneelen) können Regalbretter, Prospektablagen, Garderobenstangen, Schubladen, Pflanzengefäß oder Schließfächer angebracht werden.

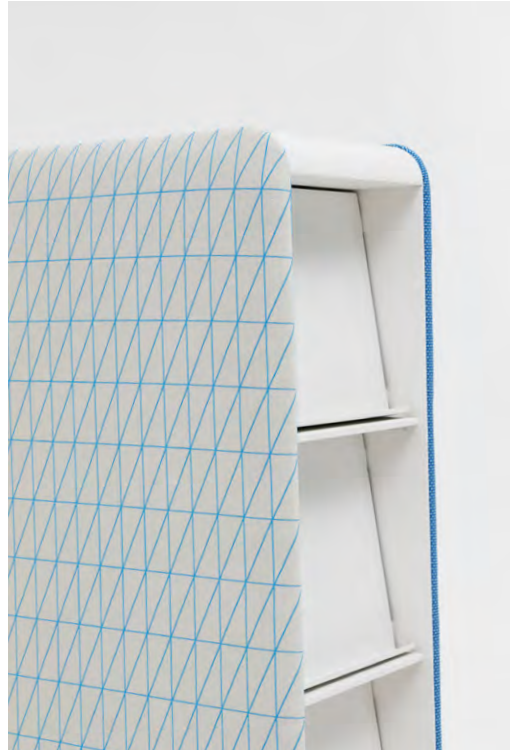

# Pillow Space

DESIGN ROBERT BRONWASSER



## SPACE DIVIDERS

Mobile space dividers; available with various functional accessories and standard or premium sound absorption. Note: for panels with accessories please always choose standard acoustic panels. Premium acoustic panels should be applied without panel accessories.

Mobile Raumteiler, lieferbar mit verschiedenen funktionellen Accessoires, in der akustischen Klasse Standard oder Premium. Achtung: für Paneele mit Accessoires bitten wir Sie, immer Standard Akustik zu wählen. Paneele mit Premium Akustik sollten immer ohne Accessoires eingeplant werden.

### MATERIAL AND FINISH

Upholstered MDF panels, powder coated steel base provided with casters with brakes

### ACOUSTIC PROPERTIES

Standard or premium, attenuation and absorption

### FABRICS

See our wide range of fabrics in chapter Fabrics

### ADDITIONAL



### DIMENSIONS (CM)

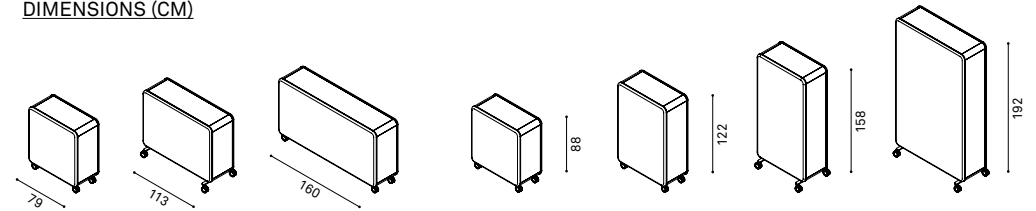

### OPTIONS INSIDE

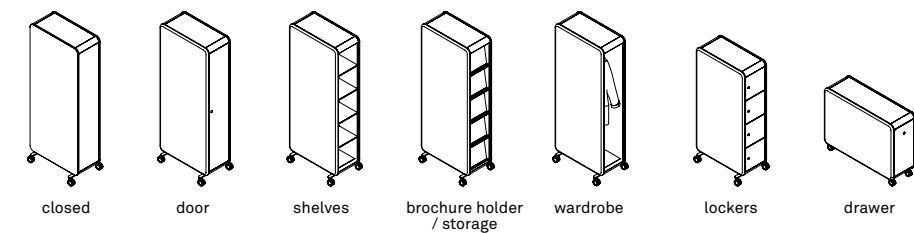

### OPTIONS PANEL SIDE

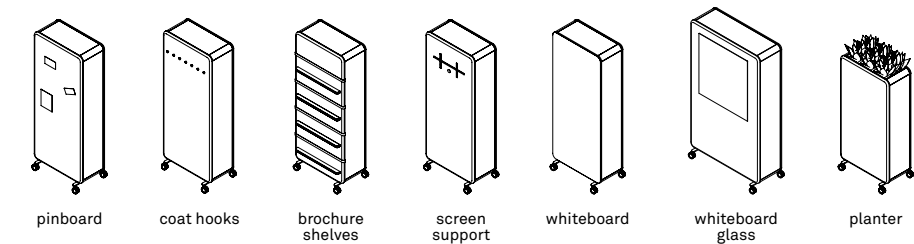

# Trunk

DESIGN ROBERT BRONWASSER







## Trunk

DESIGN ROBERT BRONWASSER

Trunk is a mobile acoustic space divider with a friendly and informal appearance. The mobile whiteboard or LCD Trunks enable presentations to customers and colleagues. The leather handle makes it easy to move around. Trunk comes in various heights and widths.

Trunk ist ein mobiler akustischer Raumteiler. Die Form ist freundlich und informell. Die verfahrbaren Whiteboard- oder LCD-Versionen eignen sich gut für Präsentationen an Kunden und Kollegen. Mithilfe von Ledergriffen können die Elemente leicht verschoben werden.



## SPACE DIVIDERS

### MATERIAL AND FINISH

Wooden frame upholstered with foam and fabric, casters with brakes, leather handle, aluminium powder coated coat hook

### FABRICS

See our wide range of fabrics in chapter Fabrics

### ACOUSTIC PROPERTIES

Standard or premium, attenuation and absorption

### DIMENSIONS (CM)

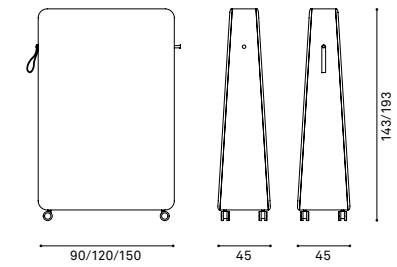

# Round20 Oak

DESIGN ROBERT BRONWASSER



## Round20 Oak

DESIGN ROBERT BRONWASSER

The oak version of the Round20 series is a beautiful lined office tool. Round20 Oak space dividers can be equipped with acoustic panels, whiteboards, coat hooks or hangers and magazine shelves. The frames are available in various colours and widths and are equipped with casters with brakes.

Die Eichenversion der Round20-Serie ist ein wunderschönes Officetool. Round20 Oak Raumteiler können mit Akustikpaneelen, Whiteboards, Kleiderhaken oder Kleiderbügel und Zeitschriftenregalen ausgestattet werden. Die Gestelle sind in verschiedenen Farben und Breiten erhältlich und mit feststellbaren Rollen ausgestattet.



MATERIAL AND FINISH

Natural or lacquert wooden uprights, casters with brakes, acoustic panel upholstered with foam and fabric

ADDITIONAL

Optional: Acoustic panel with whiteboard

ACOUSTIC PROPERTIES

Standard or premium, attenuation and absorption

FABRICS

See our wide range of fabrics in chapter Fabrics

COLOURS FRAME

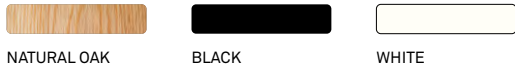

DIMENSIONS (CM)

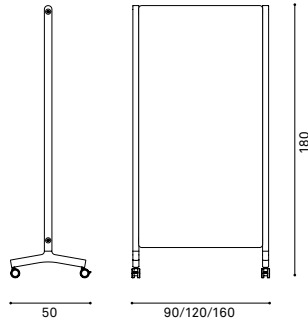

# Round20 Oak

DESIGN ROBERT BRONWASSER



# Round20 Alu

DESIGN ROBERT BRONWASSER



# Round20 Alu

DESIGN ROBERT BRONWASSER

Round20 Alu space dividers offer both visual and acoustic privacy. The aluminium version has a sleek sturdy look. Casters with brakes are standard and offer great flexibility. The acoustic fabric panels can be combined with a whiteboard on the other side. The frames come in various widths and are available in three different colours.

Round20 Alu Raumteiler bieten sowohl optischen als auch akustischen Sichtschutz. Die Aluminiumversion hat ein elegantes, robustes Aussehen. Rollen mit Bremsen sind Standard und bieten große Flexibilität. Die Akustikstoffpaneele können auf der anderen Seite mit einem Whiteboard kombiniert werden. Die Rahmen sind in verschiedenen Breiten und in verschiedenen Farben erhältlich.



CASCANDO

## SPACE DIVIDERS

### MATERIAL AND FINISH

Powder coated aluminium uprights on powder coated steel base, casters with brakes, acoustic panel upholstered with foam and fabric

### FABRICS

See our wide range of fabrics in chapter Fabrics

### COLOURS FRAME

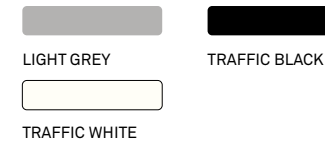

### ACOUSTIC PROPERTIES

Standard or premium, attenuation and absorption

### DIMENSIONS (CM)

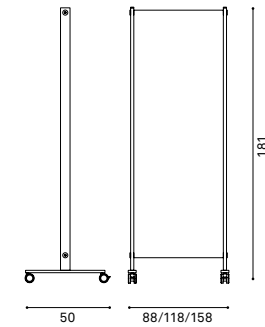



# Acoustic panels

MUTE THE NOISE AND CLEAR THE WAY FOR COZY, POSITIVE CONVERSATIONS THAT INSPIRE GOOD VIBES.

Better acoustics lead to better listening. We need that. Everywhere. It builds great ideas, inspires fun, and helps to keep your private phone conversations private.

Bessere Akustik führt zu einem besserem Verständnis. Das ist, was wir brauchen. Überall. Es führt zu besseren Ideen, regt an zum Spaß haben und hilft, dass private Telefongespräche privat bleiben.



Scan to discover  
Acoustic panels

WALL PANELS DESK PANELS CEILING PANELS

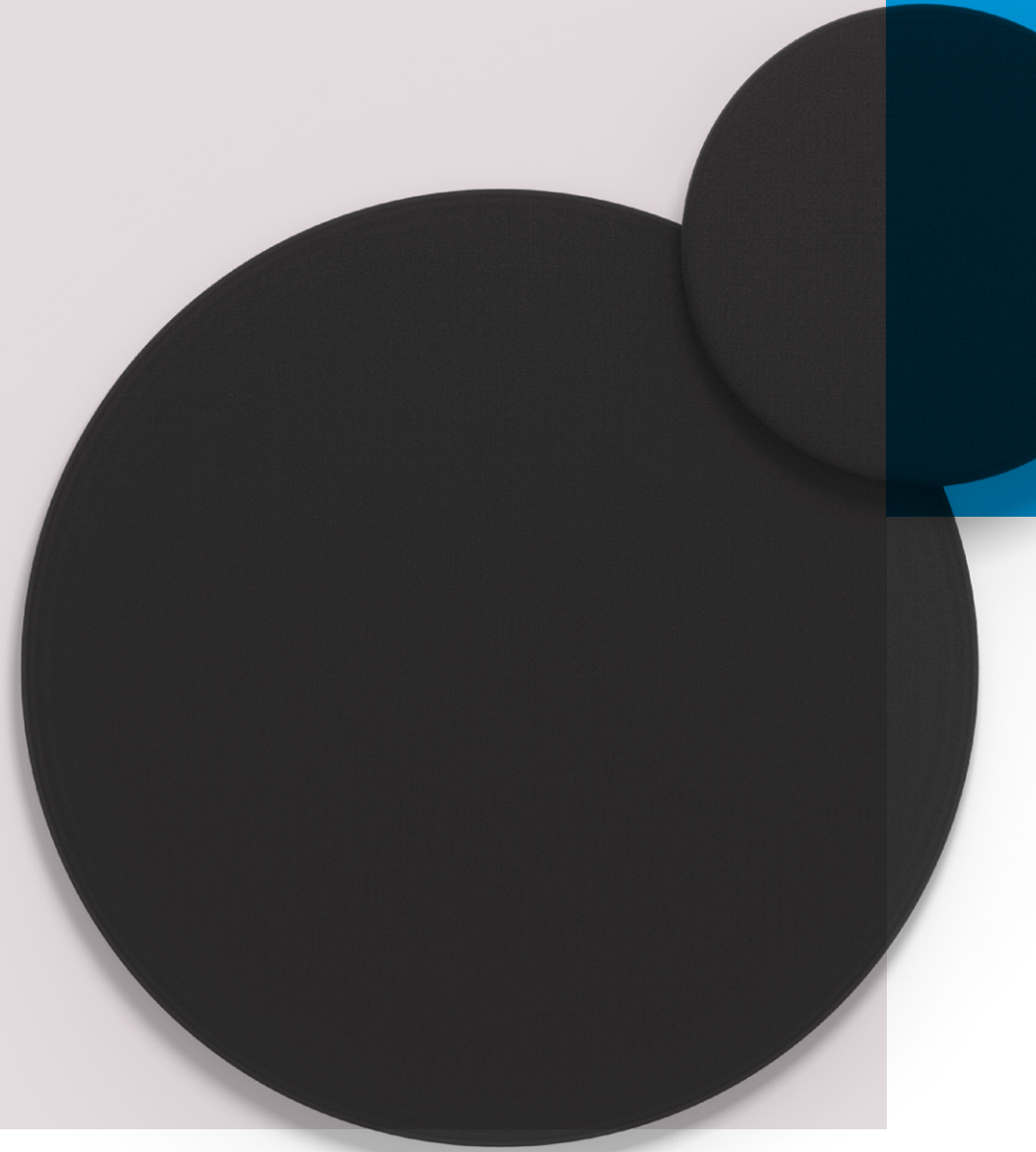

# Pillow Wall

DESIGN ROBERT BRONWASSER



## Pillow Wall

DESIGN ROBERT BRONWASSER

Decorative, sound absorbing and functional. Integrated brochure holders, coat hooks, shelves and memo straps create additional functionality. Walls become dynamic shapeshifters and gain attractiveness.

Dekorativ, schallabsorbierend und funktionell. Integrierte Prospekthalter, Kleiderhaken, Regalbretter und Spannbänder für Memotafeln verwandeln die Paneele in Multifunktionselemente. Keine statischen Wände, sondern dynamische, wandlungsfähige und reizvolle Raumteiler.

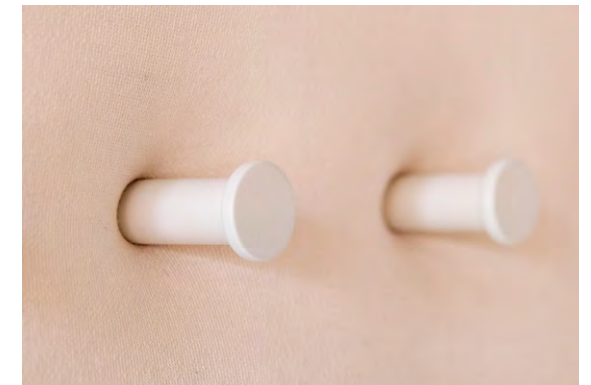



CASCANDO

Think of a Pillow as a beacon. Walls can be changed into a dynamic information centre. Magazines, brochures, maps or private possessions each have their own place on the wall. Every wall is a meeting point.

Mit diesen Wandpaneelen lässt sich ein dynamisches Informationszentrum schaffen. Zeitschriften, Prospekte, Karten und persönliche Gegenstände bekommen alle einen eigenen Platz an der Wand. So ist jede Wand auch ein Begegnungsort.

FUNCTIONS

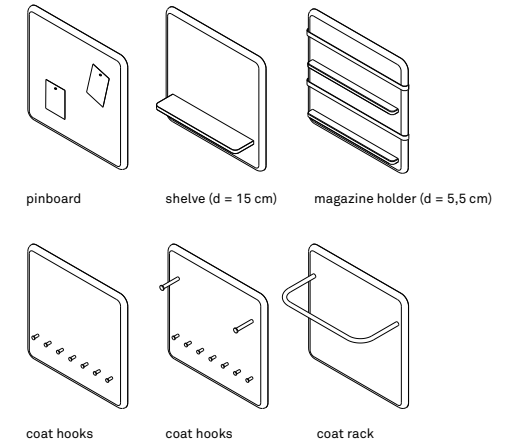

# Pillow Grid

DESIGN ROBERT BRONWASSER





## Pillow Grid

DESIGN ROBERT BRONWASSER

Pillow Grid panels have straight corners and can be used on their own or placed in a grid. Adding a memo board, magazine holder, coat rack, shelves and whiteboards in various sizes makes Pillow Grid very functional.

Die rechteckigen Pillow-Grid-Paneele können einzeln oder als Teil einer Konstellation verwendet werden. Mit Memotafeln, Prospekt-haltern, Kleiderhaken, Regalbrettern und Whiteboards in verschiedenen Größen lässt Pillow Grid sich multifunktional gestalten.

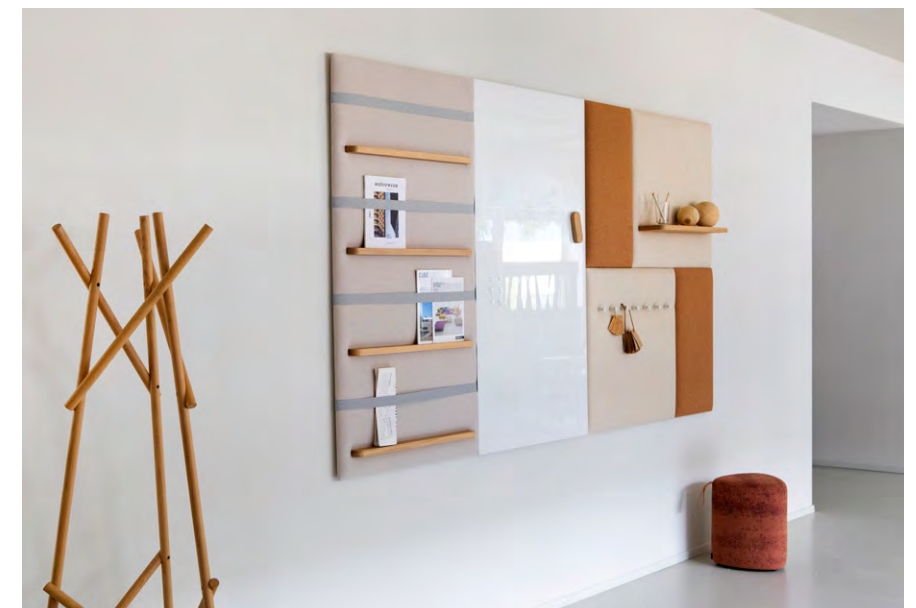
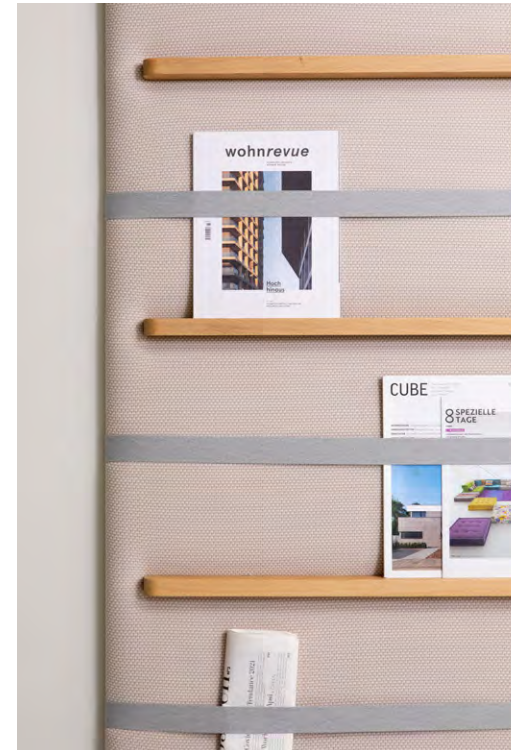

A wide range of fabrics, colours, dimensions and functions enables the design of a personal wall for any lobby, hallway, office or meeting room. Pillow Wall panels create spatial intimacy, conveying a homecoming.

Eine breite Auswahl an Stoffen, Farben, Größen und Funktionen ermöglicht den Entwurf persönlicher Wände für Empfangsbereiche, Büros oder Konferenzzimmer. Die Pillow Paneele schaffen räumliche Intimität und eine heimelige Atmosphäre.



CASCANDO





CASCANDO

The straight corners of the Pillow Grid panels enable the creation of both small and large wall designs. And with an increased range of sizes, accessories, fabrics and colours, Pillow Grid walls become a central design element in any interior.

Dank ihrer rechten Winkel kann man mit den Pillow-Grid-Paneeelen sowohl kleine als große Wandkonfigurationen mühelos zusammenstellen. Die erweiterte Auswahl an Größen, Zubehör, Stoffen und Farben garantiert, dass eine Pillow-Wand in jeder Einrichtung zum Blickfänger wird.

**FUNCTIONS**

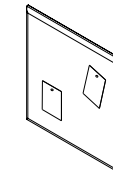

pinboard

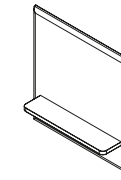

shelf (d = 15 cm)

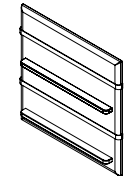

magazine holder (d = 5,5 cm)

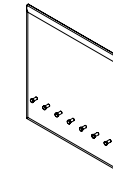

coat hooks

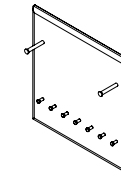

coat hooks

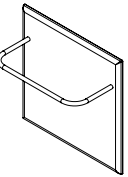

coat rack

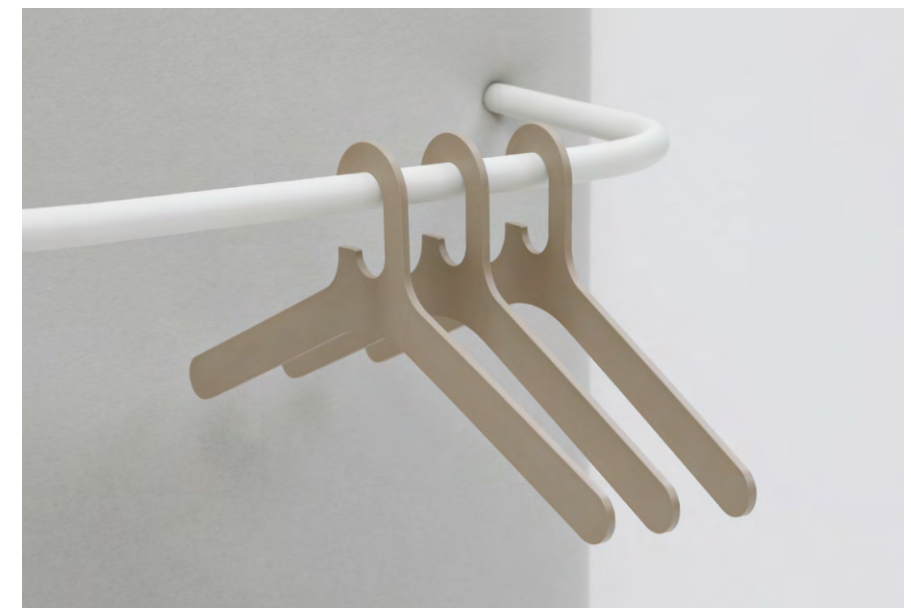



# Pillow Wall & Grid

DESIGN ROBERT BRONWASSER

Wall panels with rounded or straight corners, available with various functional accessories and standard or premium sound absorption. For panels with accessories please always choose standard acoustic panels. Premium acoustic panels should be applied without panel accessories. Standard acoustic panels thickness is 3 cm, premium acoustic panels thickness is 6 cm.

Wandpaneele mit abgerundeten oder scharfen Ecken, lieferbar mit verschiedenen funktionellen Accessoires, in der akustischen Klasse Standard oder Premium. Für Paneele mit Accessoires bitten wir Sie, immer Standard Akustik zu wählen. Paneele mit Premium Akustik sollten immer ohne Accessoires eingeplant werden. Standard akustische Paneele sind 3 cm tief, Premium akustische Paneele sind 6 cm tief.

## MATERIAL AND FINISH

Upholstered MDF panels, panel with foam and fabric, powder coated steel and aluminium wardrobe accessories, lacquered wooden magazine holders, recycled yarn straps

## FABRICS

See our wide range of fabrics in chapter Fabrics

## COLOURS SHELVES



OAK

GREY WHITE

## COLOUR STRAPS



LIGHT GREY

## COLOUR HOOKS AND BARS



GREY WHITE

## MOUNTING

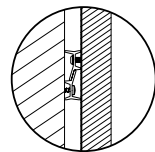

## ACOUSTIC PROPERTIES

Standard or premium, attenuation and absorption

## ADDITIONAL

Matching coat hanger: Pole hanger



## DIMENSIONS (CM)

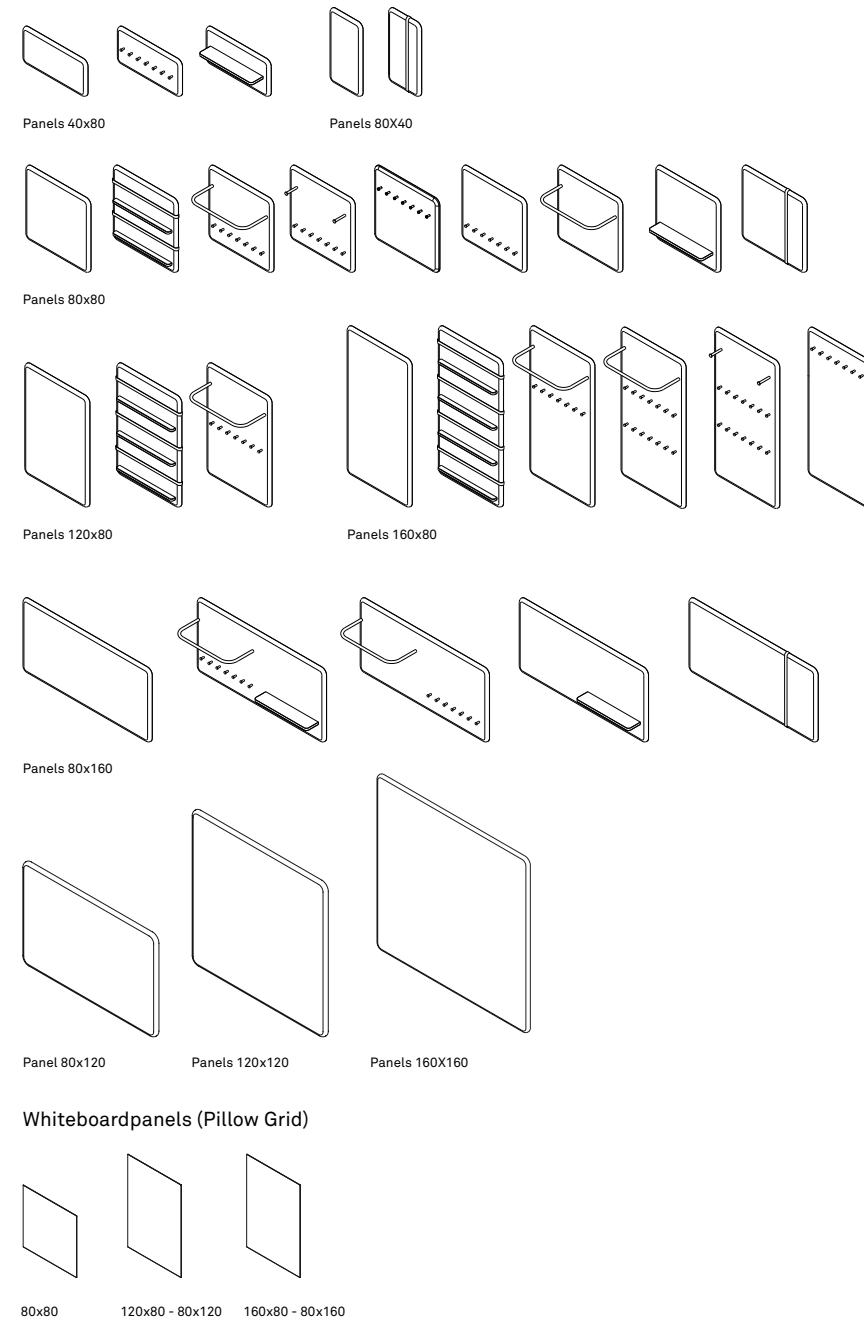

# Pillow Round

DESIGN ROBERT BRONWASSER

Three different diameters allow the creation of sound-absorbing wall designs for an entrance, lobby or office. Distance holders allow the panels to overlap. Standard or premium acoustic properties.

Mit drei verschiedenen Durchmessern lassen sich schallabsorbierende Entwürfe für Wände in Eingangsbereichen, Begegnungsbereichen und Büros schaffen. Abstandhalter ermöglichen eine überlappende Anordnung. In zwei Absorberqualitäten erhältlich.

## MATERIAL AND FINISH

Upholstered MDF panels, panel with foam and fabric, distance holders, powder coated steel

## FABRICS

See our wide range of fabrics in chapter Fabrics

## ACOUSTIC PROPERTIES

Standard or premium, absorption

## DIMENSIONS (CM)

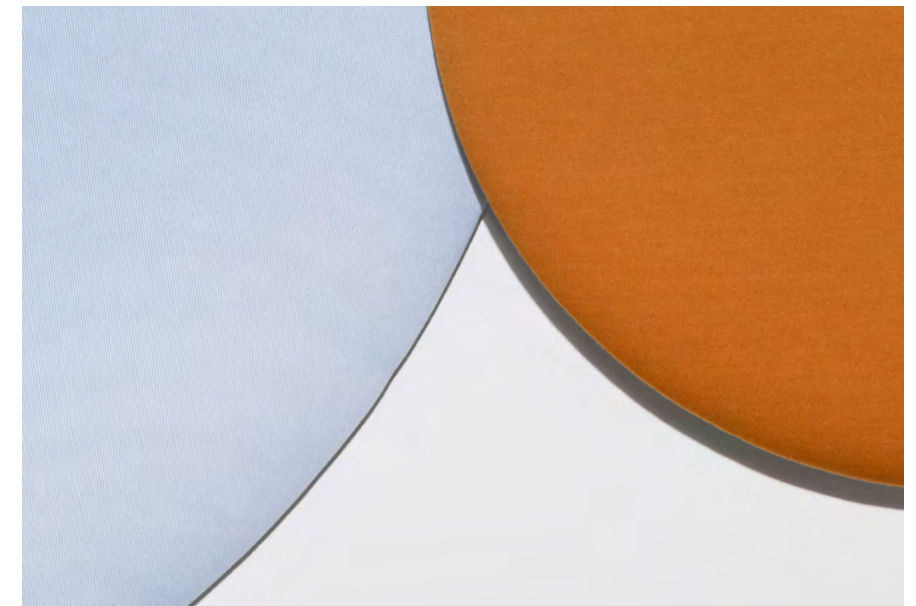
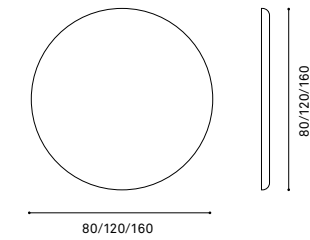

# Pillow Free

DESIGN ROBERT BRONWASSER

Pillow Free panels offer decorative and sound absorbing solutions for ceilings. They are available in round and square designs, both in various sizes. The top is covered with a black fabric. Suspension cables with height adjustment are also included.

Pillow-Free-Paneele sind dekorative akustische Deckensegel. Sie sind, sowohl rund als eckig ausgeführt, in verschiedenen Größen erhältlich. Der Rücken ist mit schwarzem Stoff bezogen. Ein höhenverstellbares Aufhängesystem ist einbegriffen.

## MATERIAL AND FINISH

Upholstered MDF panels, panel with foam and fabric

## ACOUSTIC PROPERTIES

Standard or premium, attenuation and absorption

## FABRICS

See our wide range of fabrics in chapter Fabrics

## DIMENSIONS (CM)

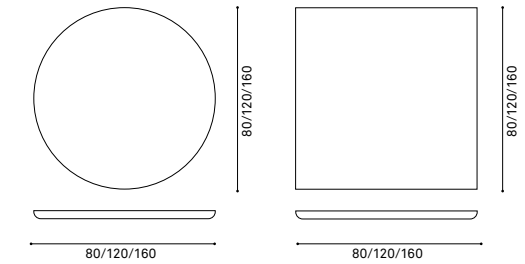

CASCANDO

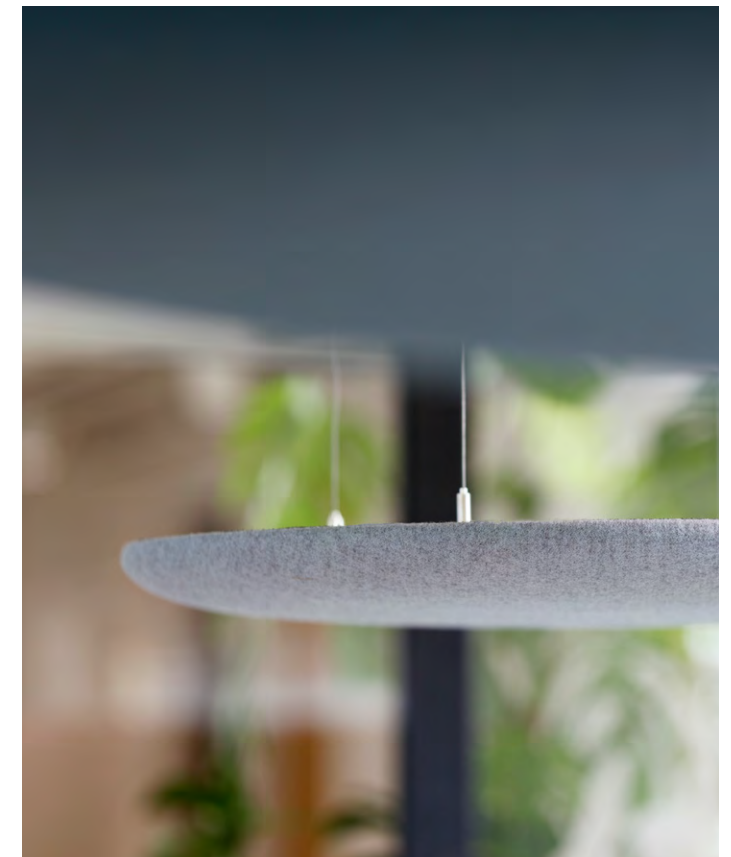



## Pillow Desk

DESIGN ROBERT BRONWASSER

Pillow Desk panels can be placed free standing on any desk offering visual privacy and sound isolation. They can also be removed easily, bringing back transparency when desired. Pillow Desk panels can also be fix mounted on, or to, a desk. Magnetic feet are an option as well.

Pillow-Desk Paneele können freistehend auf jedem Büro als Sichtschutz und Schallschirm positioniert werden. Bei Bedarf an mehr Kontakt lassen sie sich auch leicht wieder entfernen. Die Pillow-Desk Paneele können auch fest an oder auf dem Schreibtisch montiert werden. Magnetische Füßen sind ebenfalls möglich.

### MATERIAL AND FINISH

Upholstered MDF panels, panel with foam and fabric, powder coated steel base

### COLOUR BASE



GREY WHITE

### FABRICS

See our wide range of fabrics in chapter Fabrics

### ACOUSTIC PROPERTIES

Standard, attenuation and absorption

### DIMENSIONS (CM)

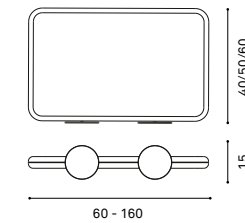

# Seating

SIMPLY SIT DOWN AND EXPERIENCE THE SOFT EMBRACE AND CHARACTER OF OUR FEEL-GOOD FURNITURE.

Sit. Stand. Lounge. We like to flex-work. Sit anywhere. Have lazy catch-ups, active scrums, encourage the use of natural seating solutions. Informal is both functional, and fantastic.

Sitzen, Stehen, Loungen. Wir lieben flexibles Arbeiten. Nimm überall Platz. Nimm teil an gemütlichen Treffen, aktiven Besprechungen, fordere auf zum Gebrauch natürlicher Sitzmöglichkeiten. Informell ist sowohl zweckmäßig als auch fantastisch. Telefongespräche privat zu halten.



Scan to discover  
Seating

SOFA'S (BAR) STOOLS BAR BENCHES POUFS

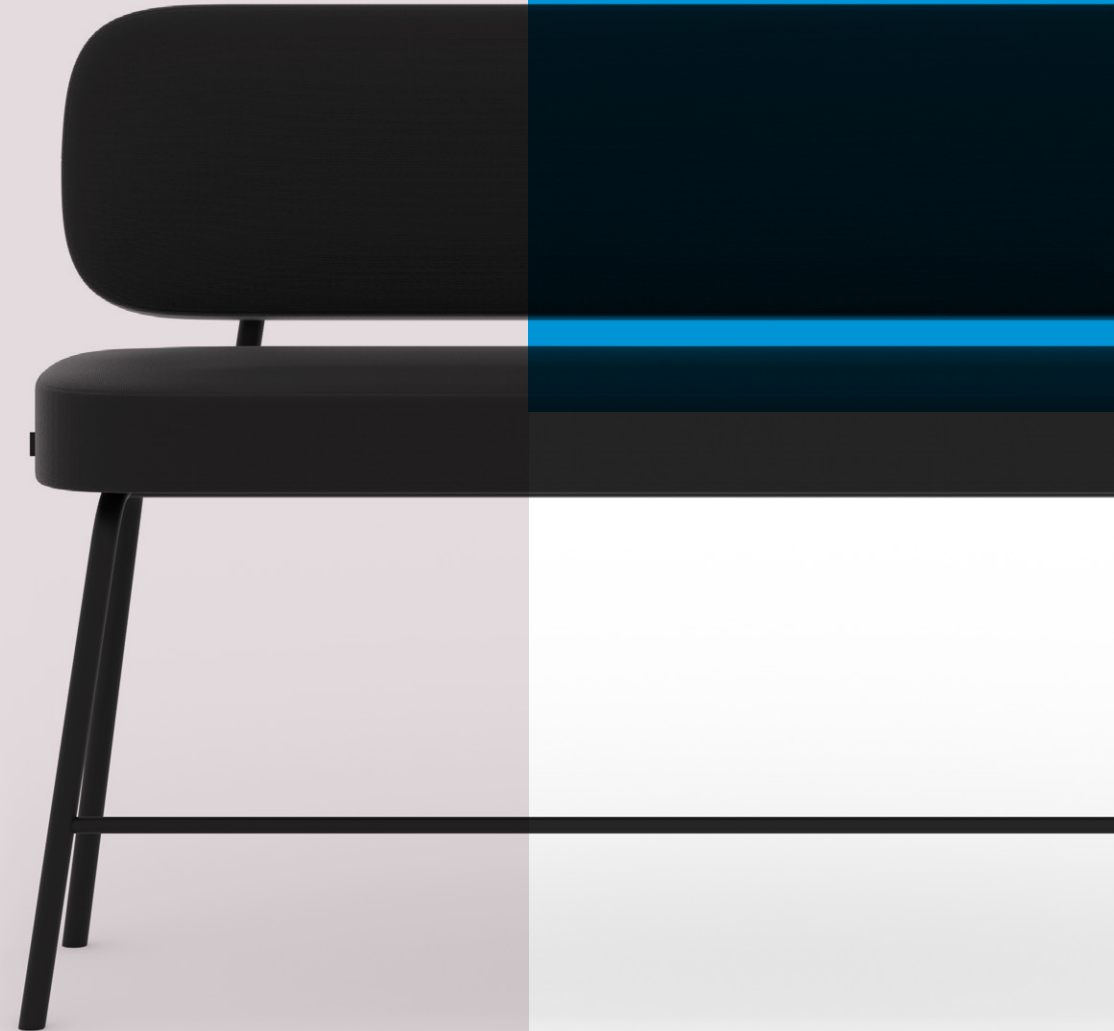

# Paddy

DESIGN ROBERT BRONWASSER

The friendly round shape of Paddy stimulates friendly conversations. While the comfortable seat is upholstered, the chassis is fashioned from threaded steel.

Die lieblich runde Form des Paddy Hockers regt zu freundlichen Gesprächen an. Der bequeme Sitz ist bepolstert und ruht auf einem Gestell aus Stahldraht.



## MATERIAL AND FINISH

Wooden frame upholstered with foam and fabric, provided with powder coated steel frame

## COLOUR FRAME



GREY WHITE



TRAFFIC BLACK

## FABRICS

See our wide range of fabrics in chapter Fabrics

## DIMENSIONS (CM)

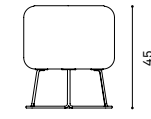
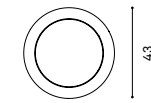

43

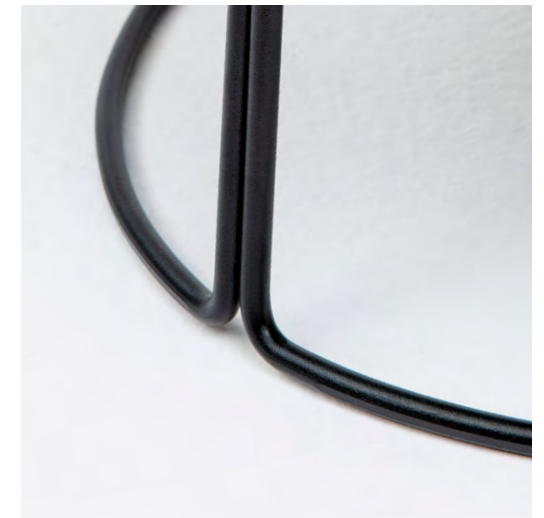

# Team Pouf

DESIGN PETER VAN DE WATER

The modern workplace is becoming more informal. We move around a lot, interact everywhere, mix individual and group sessions in an instant. The simple yet elegant Team pouf can be easily combined with any of the Team elements. Another great family member to create a proverbial agile workplace.

Der moderne Arbeitsplatz wird informeller. Wir bewegen uns viel, interagieren überall, mischen Einzel- und Gruppensitzungen im Handumdrehen. Der schlichte und doch elegante Team Pouf lässt sich gut mit allen Team-Elementen kombinieren. Ein weiteres großartiges Familienmitglied, um einen sprichwörtlich agilen Arbeitsplatz zu schaffen.

## MATERIAL AND FINISH

Wooden frame upholstered with foam and fabric, provided with plastic feet

## FABRICS

See our wide range of fabrics in chapter Fabrics

## DIMENSIONS (CM)

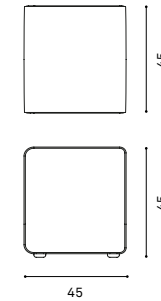

CASCANDO

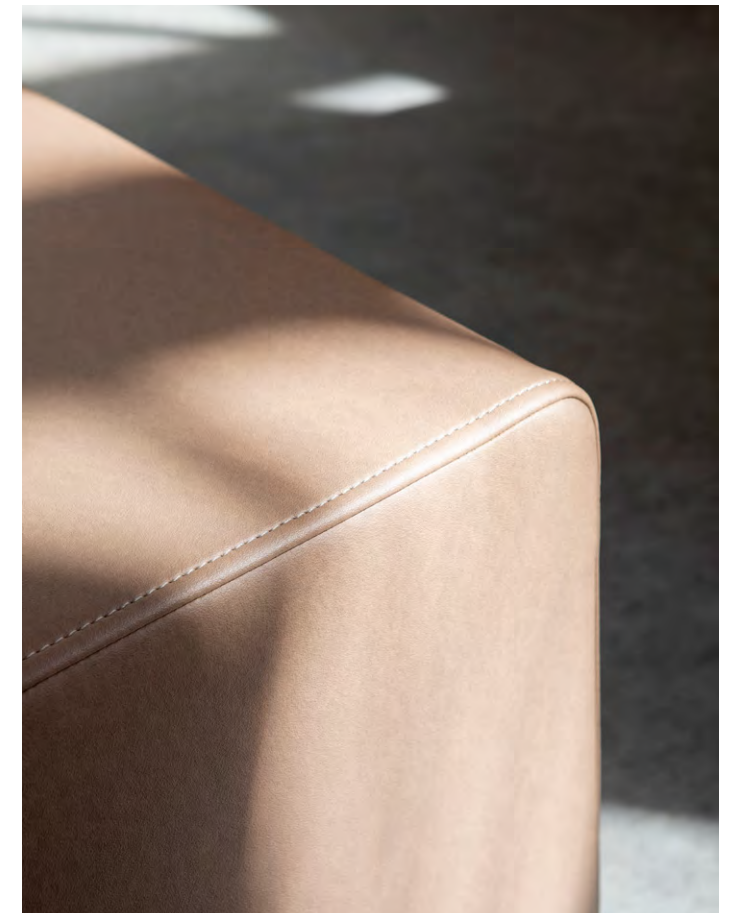

# Pully Pouf

DESIGN ROBERT BRONWASSER





# Pully Pouf

DESIGN ROBERT BRONWASSER

Pully is a pouf with a different kind of shape that defies convention. The leather handle makes it easy to carry Pully around, offering comfort and flexibility in the workplace.

Pully ist der unkonventionelle Hocker mit der etwas anderen Form. An seinem Ledergriff lässt er sich mühelos mitnehmen, sodass man seinen flexiblen Komfort überall am Arbeitsplatz genießen kann.

## MATERIAL AND FINISH

Wooden frame upholstered with foam and fabric, provided with plastic feet and leather handle

## FABRICS

See our wide range of fabrics in chapter Fabrics

## DIMENSIONS (CM)

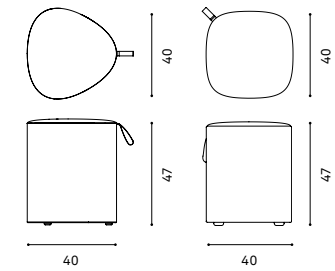

# Pully Islands

DESIGN ROBERT BRONWASSER

Original seating solutions for spaces where receiving, meeting, waiting or relaxing are central. The different shapes, sizes and the mutual distance between the elements create a playful dynamic in every space. Pully Island seating elements can be combined with matching Pully Island tables.

Originelle Sitzlösungen für Räume in denen Empfangen, Treffen, Warten oder Entspannen zentral stehen. Die verschiedenen Formen, Größen und die gegenseitige Distanz zwischen den Elementen schafft eine spielerische Dynamik in jedem Raum. Pully Island Tischen machen die Serie komplett.

## MATERIAL AND FINISH

Wooden frame upholstered with foam and fabric, provided with plastic feet

## FABRICS

See our wide range of fabrics in chapter Fabrics

## OPTIONAL

Table top, see page 176-177

## DIMENSIONS (CM)

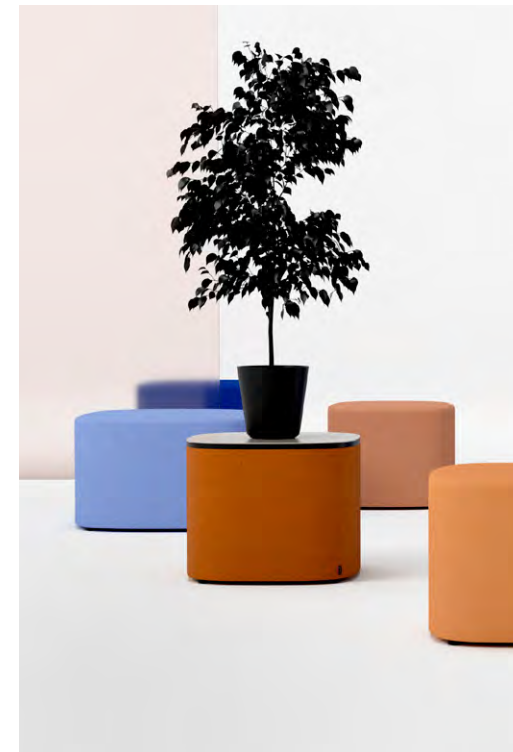
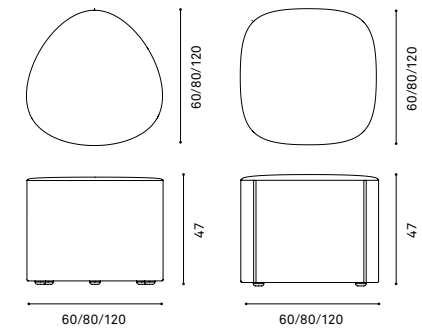

# Pully Stool

DESIGN ROBERT BRONWASSER



# Pully Stool

DESIGN ROBERT BRONWASSER

The upholstered seat of Pully Stool provides a beautiful accent in the interior. Pully Stool is available in three or four corner versions. The steel base, with integrated footrest, has a matte black textured powder coat.

Die gepolsterte Sitzfläche von Pully Stool ist ein wunderschöner Einrichtungsakzent. Pully Stool ist in dreieckiger oder viereckiger Form lieferbar. Das Stahlgestell, mit integrierter Fußraste, ist mattschwarz lackiert.

## MATERIAL AND FINISH

Wooden seat, upholstered with foam and fabric, powder coated steel frame with plastic feet

## FABRICS

See our wide range of fabrics in chapter Fabrics

## COLOUR FRAME



TRAFFIC BLACK

## DIMENSIONS (CM)

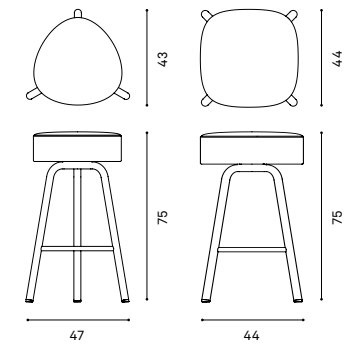

# Pully Oak Stool

DESIGN ROBERT BRONWASSER



# Pully Oak Stool

DESIGN ROBERT BRONWASSER

Pully Stool is also available with seats in solid oak, natural or black coated. The Pully Oak Stools come in two different heights.

Pully Stools sind auch erhältlich mit Sitzflächen in naturfärbiger oder schwarz lackierter, massiver Eiche. Die Pully Oak Stools sind lieferbar in zwei verschiedenen Höhen.

## MATERIAL AND FINISH

Lacquered oak seat, powder coated steel frame with plastic feet

## COLOUR FRAME



TRAFFIC BLACK

## COLOURS SEAT



OAK



TRAFFIC BLACK

## DIMENSIONS (CM)

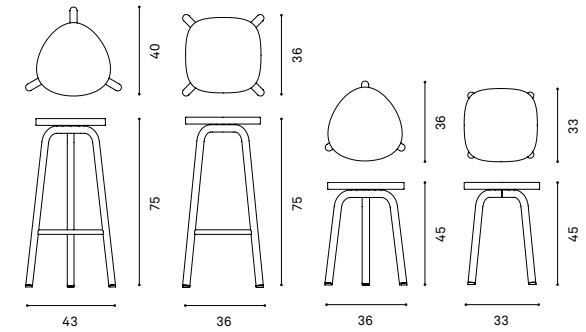

CASCANDO



123

# Pully Bench

DESIGN ROBERT BRONWASSER

Collaboration in an informal setting is actively encouraged with Pully Bench. The bench is available in various lengths. This guarantees comfort and social distance. With or without backrest, Pully Bench is perfect as a prominent seat in the lobby, lounge or open office. Pully Bench combines well with the Pully tables and bar stools.

Zusammenarbeit in einem informellen Umfeld wird mit der Pully Bench aktiv gefördert. Die Bank ist in verschiedenen Längen lieferbar. Dies garantiert Komfort und soziale Distanz. Mit oder ohne Rückenlehne, sie ist perfekt als prominenter Sitzplatz in der Lobby, Lounge oder im Büro. Die Pully Bench ist toll mit den Pully Tischen und Barhockern zu kombinieren.

## MATERIAL AND FINISH

Wooden seat and backrest, upholstered with foam and fabric, powder coated steel frame with plastic feet

## COLOUR FRAME



TRAFFIC BLACK

## FABRICS

See our wide range of fabrics in chapter Fabrics

## DIMENSIONS (CM)

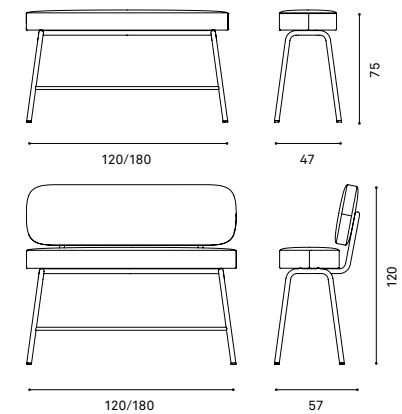

# Pully Bench Low

DESIGN ROBERT BRONWASSER

If you like to incorporate informal meetings in your spatial plans Pully Bench Low is the perfect addition. Easy seating, available in various materials and finishes, designed to complement your Pully office world.

Wenn Sie informelle Meetings in Ihre räumlichen Pläne integrieren möchten, ist Pully Bench Low die perfekte Ergänzung. Einfache Sitzgelegenheiten in verschiedenen Materialien und Ausführungen, die Ihre Pully-Bürowelt ergänzen.

## MATERIAL AND FINISH

Wooden seat, upholstered with foam and fabric, powder coated steel frame with plastic feet

## COLOUR FRAME



TRAFFIC BLACK

## FABRICS

See our wide range of fabrics in chapter Fabrics

## SEATING

## DIMENSIONS (CM)

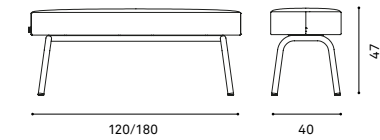

CASCANDO



127



# Pully Seat

DESIGN ROBERT BRONWASSER

Pully Seat is a sleek and soft lined easy-chair, which allows mixing active sitting with relaxing. The perfect seating standard in a waiting room or entrance hall, but also quite ideal as a seating solution in informal meeting rooms.

Pully Seat ist ein eleganter Sessel, der aktives Sitzen mit Entspannen verbindet. Der weich gefütterte Sessel ermöglicht es, aktives Sitzen mit Entspannen zu verbinden. Der perfekte Sitzstandard in einem Wartezimmer oder einer Eingangshalle, aber auch ideal als Sitzlösung in informellen Besprechungsräumen.

## MATERIAL AND FINISH

Wooden frame upholstered with foam and fabric, provided with plastic feet

## FABRICS

See our wide range of fabrics in chapter Fabrics

## DIMENSIONS (CM)

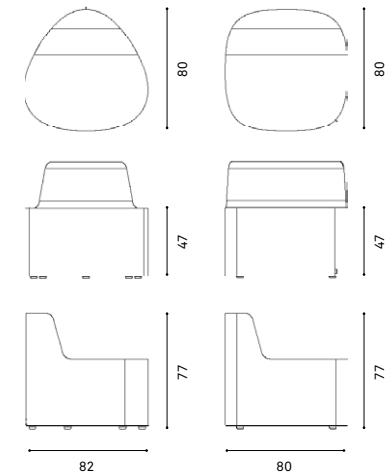

# Bond

DESIGN PETER VAN DE WATER



# Bond

DESIGN PETER VAN DE WATER

The soft rounded shell beautifully forms both back and armrest. The curvature of the back, the correct angle of the armrest and the density of the seat allow for a perfect seating experience. The slim base, in matte black, carries the seat shell in a natural way.

Die weich gerundete Schale fließt von der Rückenlehne in die Armlehne. Die Wölbung der Rückenlehne, der korrekte Winkel der Armlehne und die Stabilität der Sitzfläche erlauben eine perfekte Sitzhaltung. Das schlanke Stahlgestell, mattschwarz lackiert, trägt die Sitzschale auf eine natürliche Weise.



CASCANDO



The series includes a generous armchair, two and a half seats, three seats, five seats and a corner sofa. The side table, suitable for working on a laptop or enjoying a coffee, can be easily placed on the base as an option. The round table top which can be turned freely is available with a top finish in black Arpa Fenix or oak veneer.

Die Serie besteht aus einem großzügigen Sessel, einem extra breiten Zweisitzer, Sofas für 3 und 5 Personen und einem Ecksofa. Der Beistisch, geeignet zur Arbeit an einem Laptop oder um von einer Tasse Kaffee zu genießen, kann ganz einfach als Option in das Stahlgestell eingeschoben werden. Die Runde Tischplatte ist drehbar und ist lieferbar in Arpa Fenix schwarz und Eiche furnier.





CASCANDO

**SEATING**

**MATERIAL AND FINISH SEATING**

Wooden frame upholstered with foam and fabric, provided with powder coated steel frame

**MATERIAL AND FINISH TABLE**

Black MDF core with laquered edges provided with top layer

**FABRICS**

See our wide range of fabrics in chapter Fabrics

**COLOUR FRAME**



TRAFFIC BLACK

**COLOURS TABLE TOP**



ARPA FENIX NERO



OAK VENEER

**ADDITIONAL**

Seating can be provided with add on table.

**DIMENSIONS (CM)**

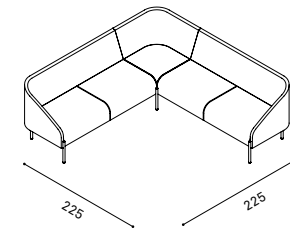
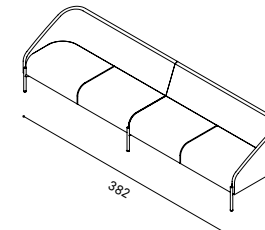
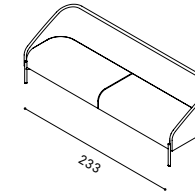
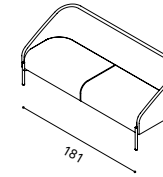
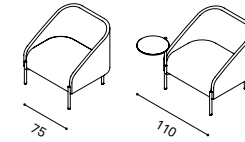
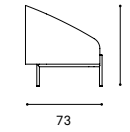

# Team BSM

DESIGN PETER VAN DE WATER





## Team BSM

DESIGN PETER VAN DE WATER

Team Basic Seating Module (BSM) is a modular seating concept creating original and flexible designs for an entrance, lounge or open office. It's a box of blocks that stimulates the imagination into maximizing any space. The soft rounded corners and the curvy backrest give Team BSM an intimate and friendly appearance.

Team Basic Seating Module (BSM) ist ein modulares Sitzsystem, mit dem originelle und flexible Konstellationen für Eingangs- und Begegnungsbereiche geschaffen werden können. Die weichgerundeten Ecken und gewölbte Rückenlehne verleihen Team eine intime und freundliche Ausstrahlung.



# Team LSM

DESIGN PETER VAN DE WATER





## Team LSM

DESIGN PETER VAN DE WATER

Team Light Seating Module (LSM) offers an inviting and appealing design for any entrance or informal meeting zone. The active seating comfort is very pleasant. The Team LSM version is equipped with steel frame and comes in various sizes.

Team Light Seating Module (LSM) bietet ein einladendes und attraktives Design für jeden Eingangs- oder Begegnungsbereich. Es lädt zum aktiven Sitzen ein und ist zudem angenehm bequem. Diese Team-Version hat ein Gestell aus Stahl und ist in verschiedenen Größen erhältlich.



**MATERIAL AND FINISH**

Wooden frame upholstered with foam and fabric

Team BSM: feet in beech wood

Team LSM: powder coated steel frame

**COLOUR FEET BSM**

BEECHWOOD



WHITE



BLACK

**COLOUR FRAME LSM**

GREY WHITE

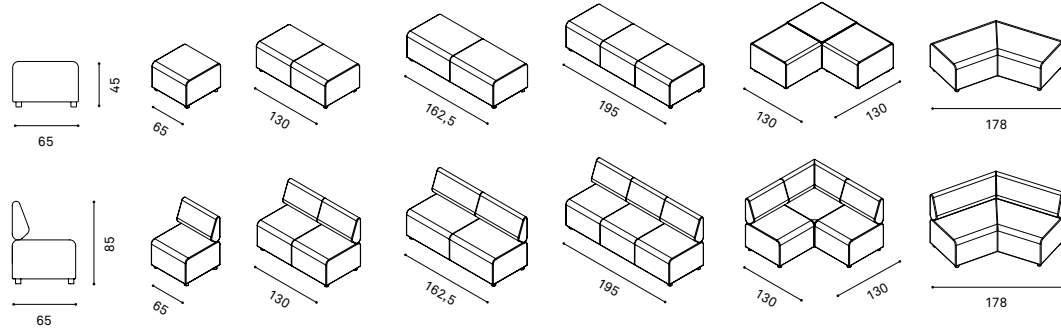
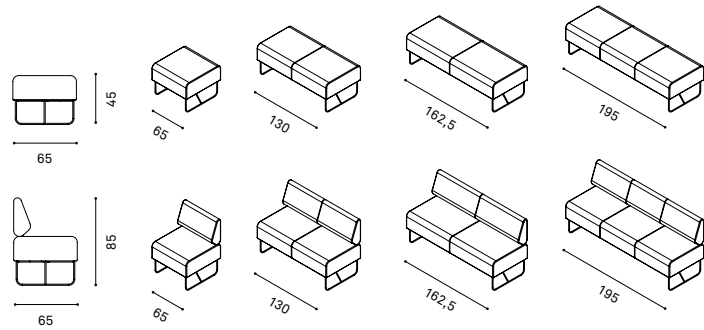
**TEAM BSM DIMENSIONS (CM)****TEAM LSM DIMENSIONS (CM)****FABRICS**

See our wide range of fabrics in chapter Fabrics



# Tables



COME TOGETHER AROUND AGILE WORK CENTERS THAT FACILITATE EVERY SINGLE ACTIVITY ON THE AGENDA.

In a world where activity based spatial design is on the rise we want tables to be like little chameleons. Low or high, they are at the heart of things. Coffee anyone?

In einer Welt in der aktivitätsbezogenes, räumliches Design im Vormarsch ist, benötigen wir Tische, die wie kleine Chamäleons sind. Niedrig oder hoch, sie sind der Kern der Sache. Jemand Kaffee?



Scan to discover  
Tables



## Bond

DESIGN PETER VAN DE WATER

The Bond table with 360° turnable table top can be used as a side table or laptop table. It has a slim steel base, in matt black. The round table top which can be turned freely is available with a top finish in black Arpa Fenix or oak veneer.

Der Bond Tisch, mit einer 360° drehbaren Tischplatte, kann sowohl als Beistelltisch als auch als Laptop Tisch verwendet werden. Die runde, frei drehbare, Tischplatte, ist mit einer Oberflächenbearbeitung in Arpa Fenix oder Eichen Furnier erhältlich.

### MATERIAL AND FINISH

Powder coated steel base, black MDF table top with lacquered edge and top finish

### COLOUR FRAME



TRAFFIC BLACK

### COLOURS TABLE TOP



ARPA FENIX NERO



OAK VENEER

### DIMENSIONS (CM)

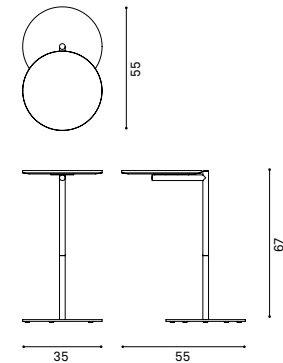

# Pully Side

DESIGN ROBERT BRONWASSER

Laptop on it, mobile on the ear, a coffee on the side. Pully side is a slim side table that transforms every seating element into an all-round workstation. All components are made of steel: the stable base, the upright and the thin table top. All in matte black textured powdercoating. The shape is triangular or square with rounded corners.

Laptop am Tisch, Telefon am Ohr und eine Tasse Kaffee nebenbei. Der Pully Tisch ist ein schlanker Beistelltisch der jedes Sitzelement im Raum umzaubert in einen vielseitigen Arbeitsplatz. Alle Komponenten sind aus Stahl gefertigt: der stabile Fuss, die Stange und die dünne Tischplatte. Alles pulverbeschichtet in matt schwarzem Texturlack. Die Form ist drei- oder viereckig mit abgerundeten Ecken.

## MATERIAL AND FINISH

Powder coated steel frame and table top

## COLOUR



TRAFFIC BLACK

## DIMENSIONS (CM)

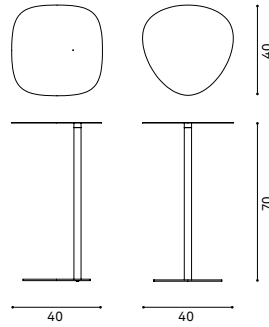

## Team Laptop

DESIGN PETER VAN DE WATER

This slender steel laptop table is the perfect partner for many seating elements. Its freestanding design makes it a practical addition to all types of seating arrangements. The table top can easily be moved into the desired position.

Dieser schmale Laptop Tisch aus Stahl ist der perfekte Partner für viele Sitzelemente. Das freistehende Design ist eine praktische Ergänzung zu allen Arten von Sitzgelegenheiten. Die Tischplatte kann einfach in jede gewünschte Richtung gedreht werden.

### MATERIAL AND FINISH

Powder coated steel frame and table top

### COLOURS

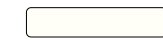

TRAFFIC WHITE



TRAFFIC BLACK

### DIMENSIONS (CM)

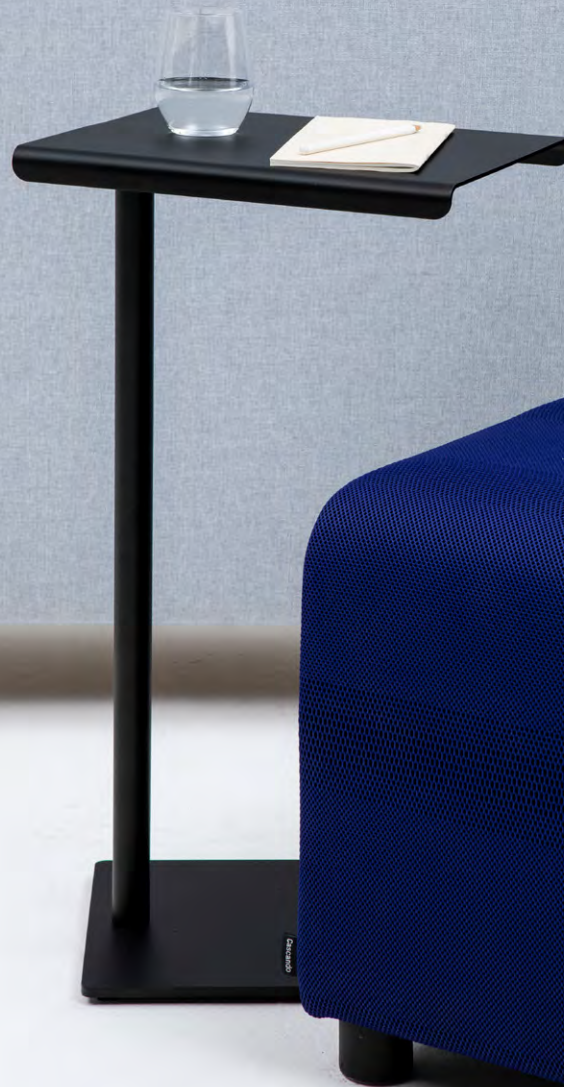
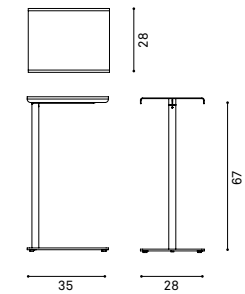

# Paddy

DESIGN PETER VAN DE WATER

Paddy is a side table with a subtle wire frame and a lacquered MDF table top. The rounded edges of the table top ensure a friendly and accessible look, perfectly matching the Paddy stools. Available in white and black.

Paddy ist ein Beistelltisch mit einem subtilen Stahlrahmen und einer lackierten MDF Tischplatte. Die abgerundeten Kanten der Tischplatte sorgen für ein freundliches und zugängliches Aussehen, perfekt passend zum Paddy Hocker. Lieferbar in Weiß und Schwarz.

## MATERIAL AND FINISH

Powder coated steel frame, MDF table top

## COLOURS TABLE TOP

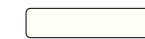

TRAFFIC WHITE



TRAFFIC BLACK

## COLOURS FRAME

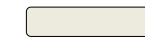

GREY WHITE



TRAFFIC BLACK

## DIMENSIONS (CM)

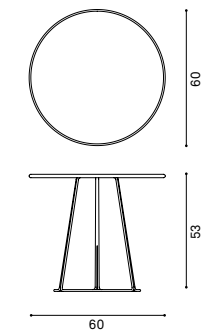

# U2 XL

DESIGN PETER VAN DE WATER

Because of its open shape, it's possible to perfectly slide a U2 side table over a bench or sofa. The multifunctional table is equipped with a convenient magazine rack and can be used either standing up or in a landscape position. The outside is painted matt, the inside has a high gloss finish.

Durch die offene Formgebung kann der Beistelltisch U2 perfekt über eine Sitzbank oder ein Sofa geschoben werden. Dieser multifunktionelle Tisch enthält einen praktischen Zeitschriftenständer und kann stehend oder liegend verwendet werden. Die Außenseite ist matt, die Innenseite hochglänzend.



CASCANDO

## MATERIAL AND FINISH

Powder coated steel

## COLOURS



TRAFFIC WHITE

TRAFFIC BLACK

## DIMENSIONS (CM)

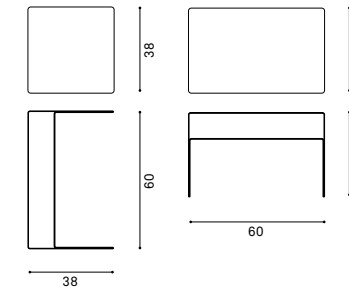





## Pully Hub

DESIGN ROBERT BRONWASSER

The Pully Hub tables are ideal for a quick meeting, a catch-up or sharing a sandwich. They combine perfectly with the quirky design of the Pully bar stools and poufs. The series includes coffee tables, working tables and standing tables. The table frame is made of steel, matt black powdercoated.

Die Pully Hub Tische sind ideal für ein schnelles Meeting, ein kurzes Wiedersehen oder für ein gemeinsamen Snack. Sie passen perfekt zu dem spielerischen Design der Pully Barhocker und Pully Hocker. Die Serie umfasst einen Couchtisch, einen Arbeits/Besprechungstisch und einen Stehtisch. Das Tischgestell besteht aus mattschwarzem Stahl.

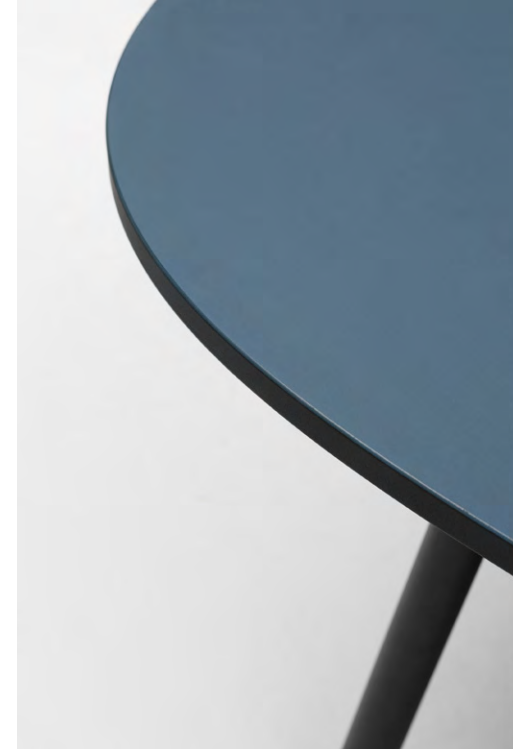

**MATERIAL AND FINISH**

Powder coated steel frame, MDF table top with black edges, table top finish in HPL, Forbo Desktop, Arpa Fenix or veneer

**COLOUR FRAME**



TRAFFIC BLACK

**COLOURS HPL TABLE TOP**



VOLCANO BLACK



SIGNAL GREY



OPAL WHITE



OAK

**COLOURS ARPA FENIX**



NERO



GRIGIO BROMO



GRIGIO LONDRA



BIANCO MALE

**COLOURS FORBO DESKTOP**



NERO



ASH



PEBBLE



**COLOUR VENEER**



OAK

**ADDITIONAL**

Other finishes or colours on request.

**DIMENSIONS**

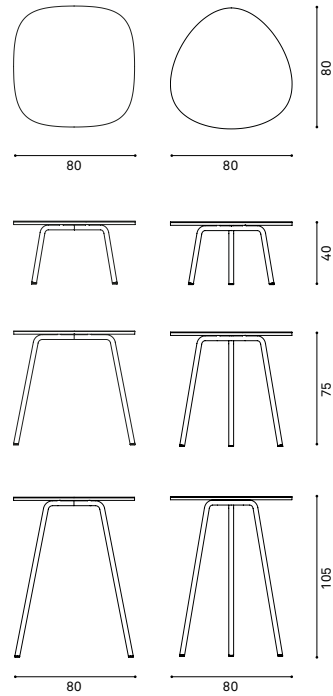

# Pully Meet

DESIGN ROBERT BRONWASSER



## Pully Meet

DESIGN ROBERT BRONWASSER

Working together, eating a sandwich, meeting, video calling. You will experience work better at a work or conference table from the Pully Meet series. The rounded corners invite you to participate, sitting or standing. Perfect in combination with Pully Bench or Pully Stool.

Zusammen arbeiten, ein Sandwich essen, Besprechungen und Video Calls halten. Sie werden Ihre Arbeit an einem Arbeits- oder Besprechungstisch der Pully Serie als angenehmer erfahren. Die abgerundeten Ecken laden zur Teilnahme ein; sitzend oder stehend. Perfekt zu kombinieren mit der Pully Bench oder dem Pully Stool.



The optional table inserts, with beautifully detailed handle / cable entry give access to the cable tray.

Die optionalen Tischeinsätze, mit wunderschön detaillierten Handgriffen/Kabeleinführungen ermöglichen den Zugriff zur Kabeltrasse.



CASCANDO

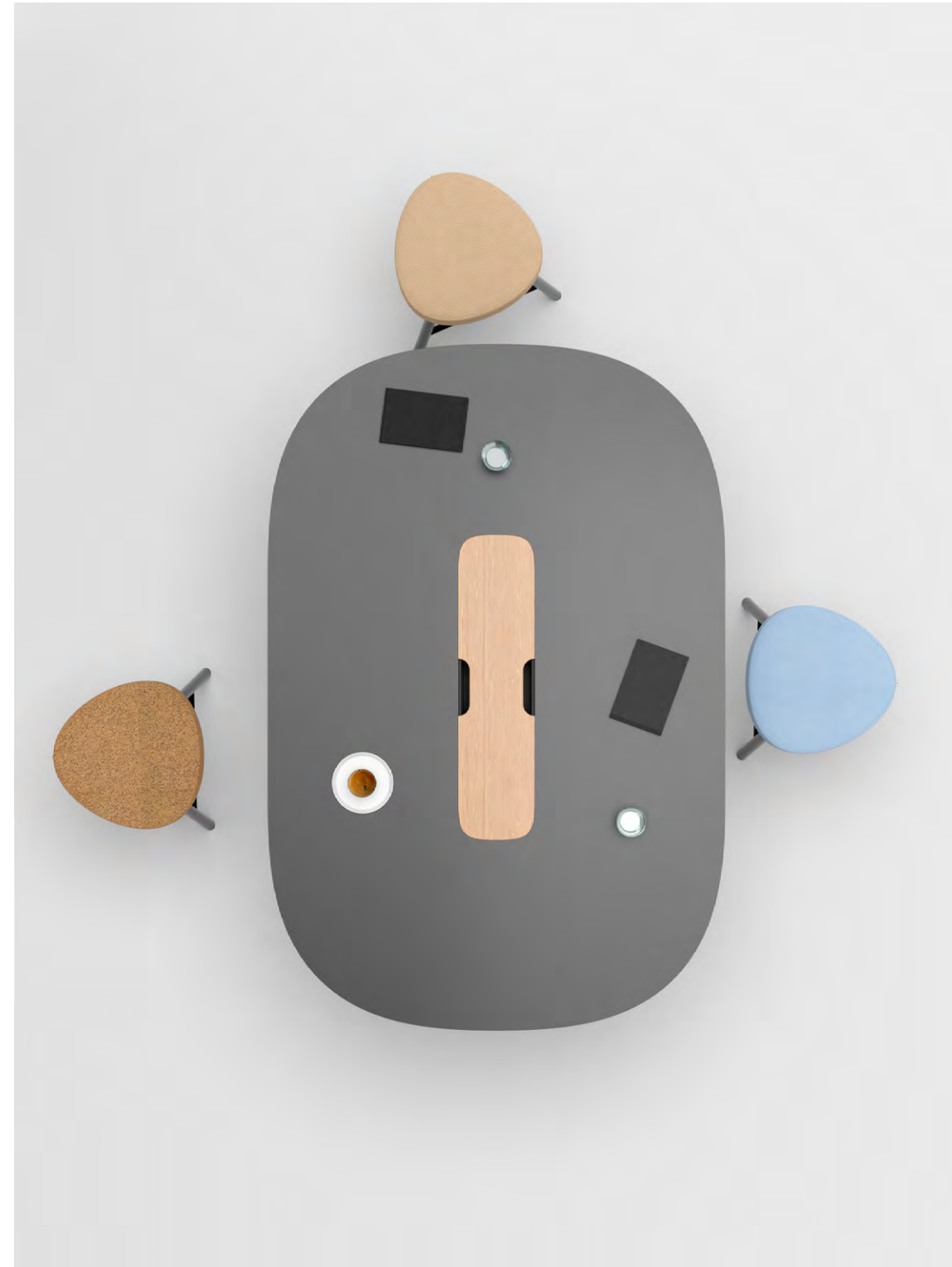

**MATERIAL AND FINISH**

Powder coated steel frame, MDF table top with black edges, table top finish in HPL, Forbo Desktop, Arpa Fenix or veneer

**COLOUR FRAME**



**COLOURS HPL TABLE TOP**

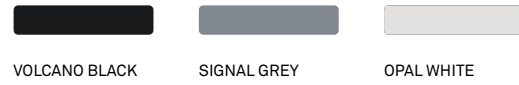

**COLOURS ARPA FENIX**

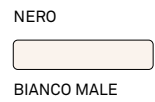

**COLOURS FORBO DESKTOP**



**COLOUR VENEER**



**ADDITIONAL**

Other finishes or colours on request

**DIMENSIONS**

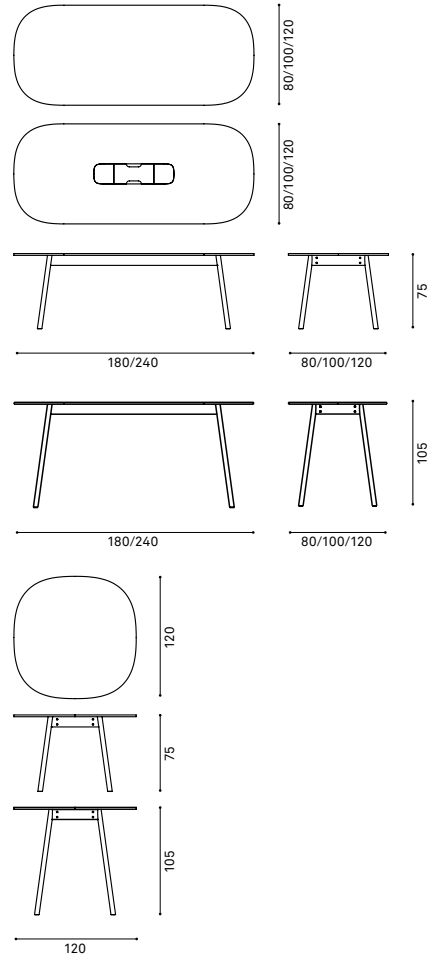



## Pully Pillar

DESIGN ROBERT BRONWASSER

Pully Pillars offer new solutions for meeting and working. Pully Pillars are single person standing tables, which can be placed at any desired distance from each other. You work standing or sitting at a Pully Pillar, for example on a matching Pully Stool. Both are possible.

Pully Pillar Tische bieten neue Lösungen für Meetings und individuelles Arbeiten. Pully Pillars sind Einzel-Stehtische, die in gewünschtem Abstand zueinander platziert werden können. An einem Pully Pillar arbeiten Sie stehend oder sitzend, zum Beispiel auf einem Pully Stool.



**MATERIAL AND FINISH**

Wooden frame upholstered with foam and fabric,  
MDF table top with black edges, table top finish in  
HPL, Forbo Desktop, Arpa Fenix or veneer,  
aluminium coat hook

**FABRICS**

See our wide range of fabrics in chapter Fabrics

**COLOURS HPL TABLE TOP**



OAK

**COLOURS ARPA FENIX**

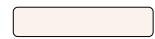
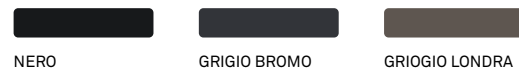

BIANCO MALE

**COLOURS FORBO DESKTOP**



OLIVE

**COLOUR VENEER**



OAK

**ADDITION**

Other finishes or colours on request

**DIMENSIONS**

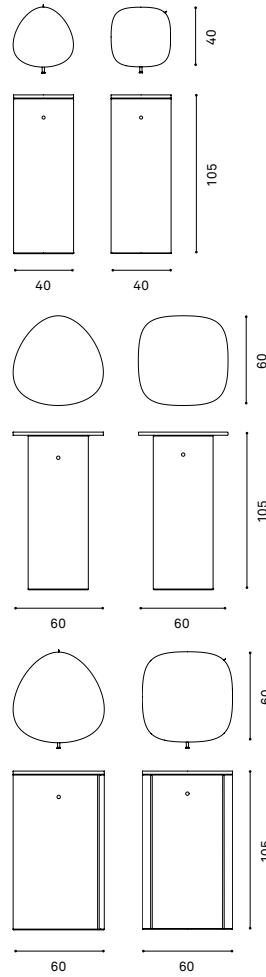



# Pully Islands

DESIGN ROBERT BRONWASSER

Pully Island tables combine perfectly with Pully Island seating elements of Pully Poufs. The upholstered base is sound absorbing. The tables are available in triangular or square shapes with rounded corners and come with table tops in various finishes.

Pully Island Tische lassen sich perfekt kombinieren mit Pully Island Sitzelementen oder Pully Hockern. Das gepolsterte Tischgestell ist schallabsorbierend. Die Tische sind lieferbar in drei- oder viereckiger Form mit abgerundeten Ecken, mit Tischplatte in verschiedene Oberflächen.



CASCANDO

## TABLES

### MATERIAL AND FINISH

Wooden frame upholstered with foam and fabric, MDF table top with black edges, table top finish in HPL, Forbo Desktop, Arpa Fenix or veneer

### FABRICS

See our wide range of fabrics in chapter Fabrics

### COLOURS TOPLAYERS

See page 174

### DIMENSIONS (CM)

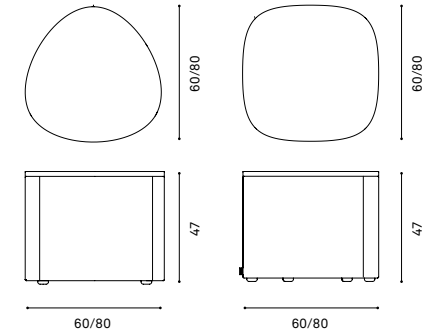

177

# Wardrobes

STATE YOUR IDENTITY TO PEOPLE THAT ENTER THE ROOM AND IMPRESS THEM WITH A SERVICE ORIENTED ATMOSPHERE.

Dry or wet, when you enter the office you want to hang your stuff neatly – the umbrella in the bin. Organise it. An inviting entrance will build a fabulous first impression.

Nass oder trocken, wenn Du das Büro betrittst möchtest du deine Sachen ordentlich aufhängen – den Schirm im Ständer. Organisiere es. Ein einladender Eingang macht einen fantastischen ersten Eindruck.



Scan to discover  
Wardrobes

COAT STANDS COAT RACKS COAT HOOKS COAT HANGERS





## Flower

DESIGN ROBERT BRONWASSER

Flower creates a pleasant and inviting atmosphere. This award winning coat stand has a beautifully lined wardrobe crown with large and smaller loop hooks for at least ten coats. The heavy cast iron base and steel upright ensure optimal stability. Flower is available in eight contemporary colours.

Flower sorgt für eine angenehme und einladende Atmosphäre. Der preisgekrönte Garderobenständer hat eine wunderschön entworfene Garderobekrone mit großen Schlaufen und kleinen Haken für mindestens zehn Mäntel. Der schwere gusseiserne Fuß sorgt für optimale Stabilität. Flower ist in acht modernen Farben erhältlich.



Let your coat, umbrella, or bag shine on our Flower. Make every room bloom with this fine lightweight design coat stand. Available with eight assorted colours and with an extra lower crown to safely carry your brolly.

Lassen Sie Ihren Mantel, Regenschirm oder Ihre Tasche auf unserer Blume erstrahlen. Bringen Sie jeden Raum mit diesem feinen, leichten Design-Garderobenständer zum Blühen. Erhältlich in acht verschiedenen Farben und mit einer zusätzlichen unteren Krone, um Ihren Schirm sicher zu tragen.



CASCANDO

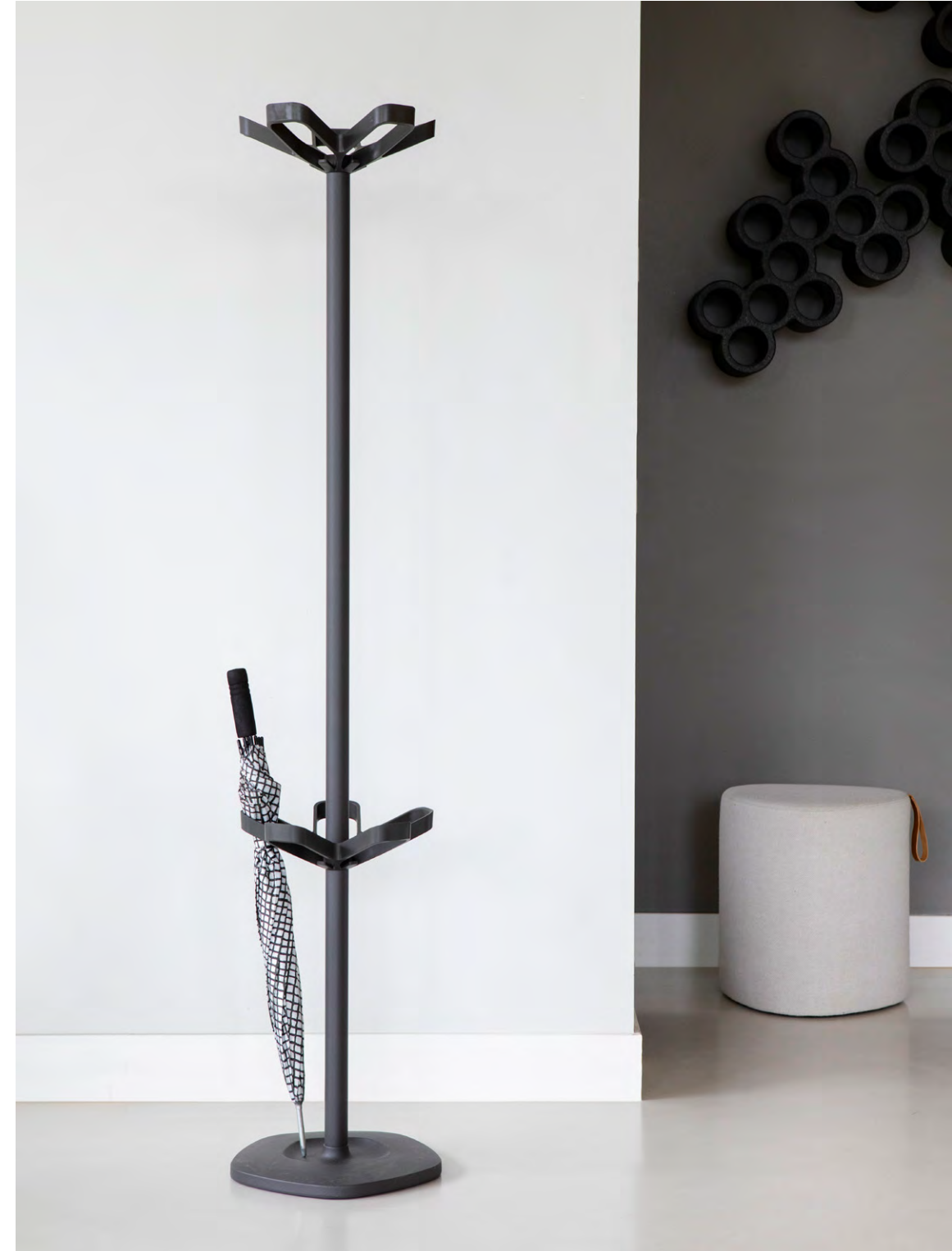



CASCANDO

**MATERIAL AND FINISH**

Polyamide crown, powder coated steel tube and cast iron base

**COLOURS**



**DIMENSIONS (CM)**

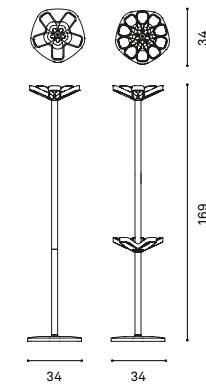

**ADDITIONAL**



# Flow Square

DESIGN MARLEEN VALSTAR

With eight large hooks above and small hooks below, the Flow Square is attractive, yet highly practical. The crown, pole and stable steel base are coated in matt white or matt black.

Durch die acht großen Haken mit kleinen Häkchen darunter ist Flow Square attraktiv und zugleich sehr praktisch. Die Krone, Stange und der stabile Fuß aus Stahl sind matt Weiß oder matt Schwarz lackiert.

## MATERIAL AND FINISH

Powder coated crown, upright and base

## COLOURS

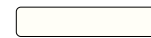

TRAFFIC WHITE



TRAFFIC BLACK

## DIMENSIONS (CM)

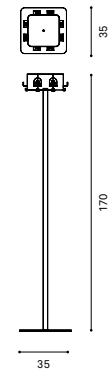

CASCANDO

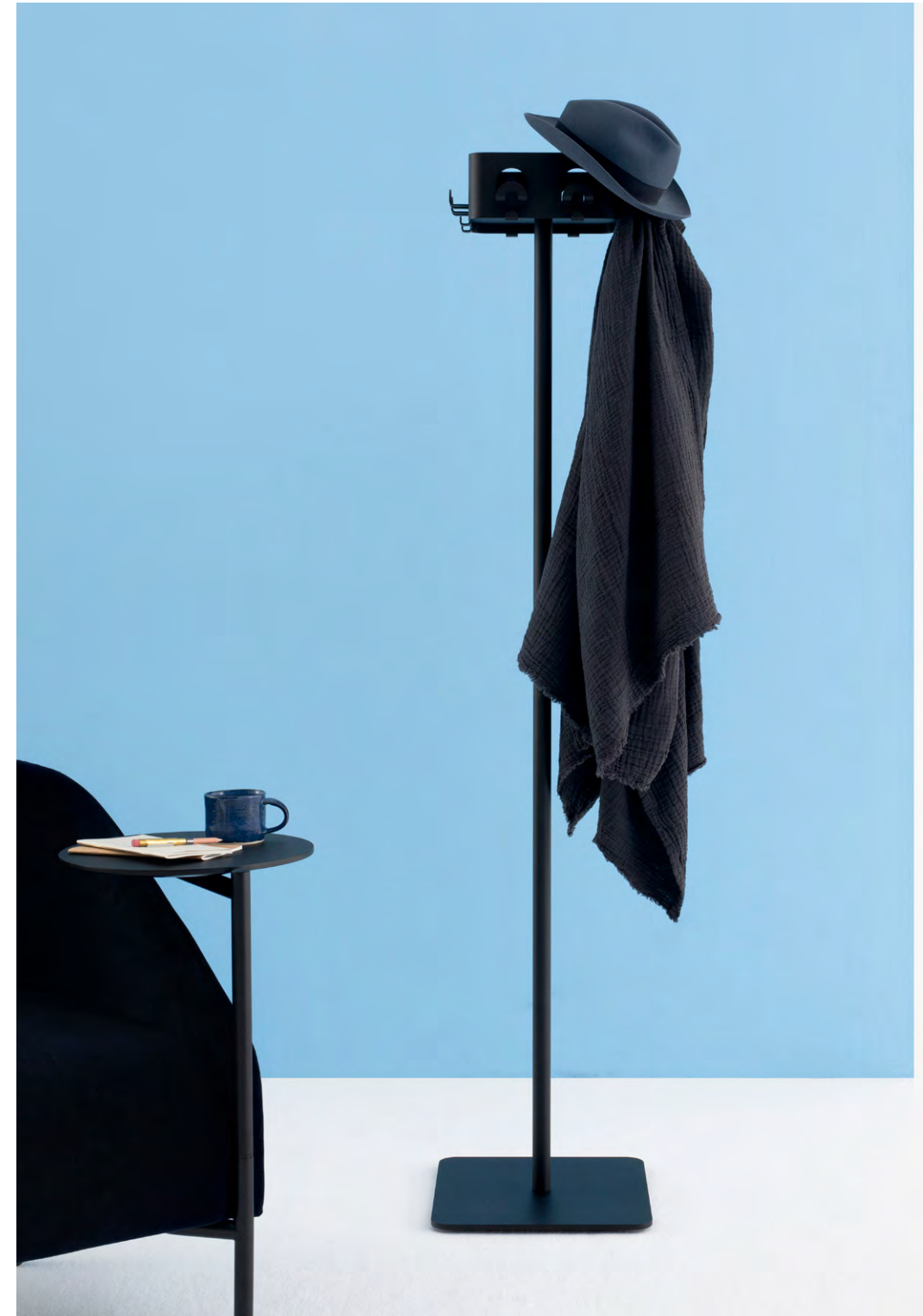



## Plus

DESIGN ROBERT BRONWASSER

Plus is a smart and inventive coat stand: the inside of the hanger platform can be equipped with eight to twelve hooks, four to six hangers or even a combination of both (three hooks and three hangers or four hooks and four hangers). The cast iron base ensures maximum stability. An umbrella holder can be placed as an option.

Plus ist ein ausgeklügelter Garderobenständer: Plus kann mit acht bis zwölf Haken, vier bis sechs Kleiderbügeln oder einer Kombination daraus ausgestattet werden. Gusseisernen Fuß garantiert optimale Stabilität. Als Option kann ein Schirmhalter hinzugefügt werden.





**MATERIAL AND FINISH**

Polyamide crown, powder coated aluminium tube and cast iron base

**COLOURS**

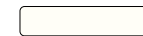

TRAFFIC WHITE



SILK GREY



BASALT BLACK



DUSTY GREEN



GREY BLUE LIGHT

**DIMENSIONS (CM)**

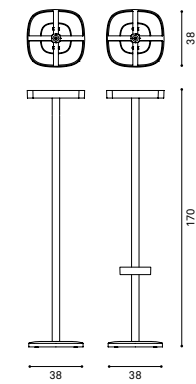

**ADDITIONAL**

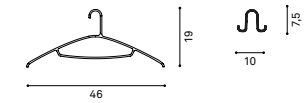





CASCANDO

## Standalone

DESIGN DE KNEGT & VAN DEIJNEN

Standalone simply leans against the wall. The curved shape of the upright and the rubber sleeves at the base create perfect stability. The grooved horizontal bar of polished aluminium accommodates five coat hangers.

Standalone lehnt einfach gegen die Wand. Die gebogene Form des Ständers und die schwarzen Bodenmanschetten aus Gummi bieten perfekte Stabilität. Die mit Rillen versehene Garderobenstange aus poliertem Aluminium bietet Platz für fünf Kleiderbügel.

### MATERIAL AND FINISH

Powder coated aluminium upright, polished aluminium horizontal bar and foot, rubber sleeved base

### COLOUR



ALUMINIUM

### DIMENSIONS (CM)

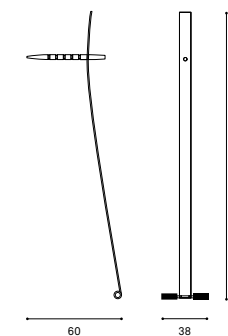

### ADDITIONAL

Matching hanger: Chrome hanger



# Standfree

DESIGN ONNO DE KNEGT

Standfree is an iconic and stylish eye-catcher. The symmetrical shape and polished aluminium accents give the coat stand a formal, well presented appearance. The steel base ensures optimal stability. The umbrella holder is optional.

Standfree ist ein ikonischer, stilvoller Eyecatcher. Die symmetrische Form und die Akzente aus poliertem Aluminium geben dem Garderobenständer eine formelle, repräsentative Ausstrahlung. Die Fertigung aus Stahl sorgt für optimale Stabilität. Der Schirmhalter ist optional.



**MATERIAL AND FINISH**

Powdercoated aluminium upright, polished or powder coated horizontal bar, powder coated steel base

**ADDITIONAL**

Matching coat hanger: Chrome hanger

**COLOURS BASE AND UPRIGHTS**



ALUMINIUM



TRAFFIC WHITE



ANTHRACITE GREY

**COLOUR HORIZONTAL BARS**



POLISHED ALU



TRAFFIC WHITE



TRAFFIC BLACK

**DIMENSIONS (CM)**

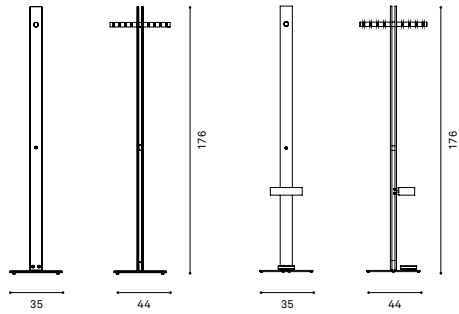

# Basket

DESIGN PETER VAN DE WATER

Basket is made from steel wires, woven together using industrial craftsmanship. The wires form a symmetrical pentagon at the base. A practical coat stand, but above all a timeless and architectural object.

Basket besteht aus Stahldrähten, fachmännisch industriell ineinander verwoben. Die Drähte bilden an der Basis ein symmetrisches Fünfeck. Ein praktischer Garderobenständer, aber vor allem ein zeitloses und architektonisches Objekt.

## MATERIAL AND FINISH

Powder coated steel frame

## COLOURS



TRAFFIC WHITE



TRAFFIC BLACK

## DIMENSIONS (CM)

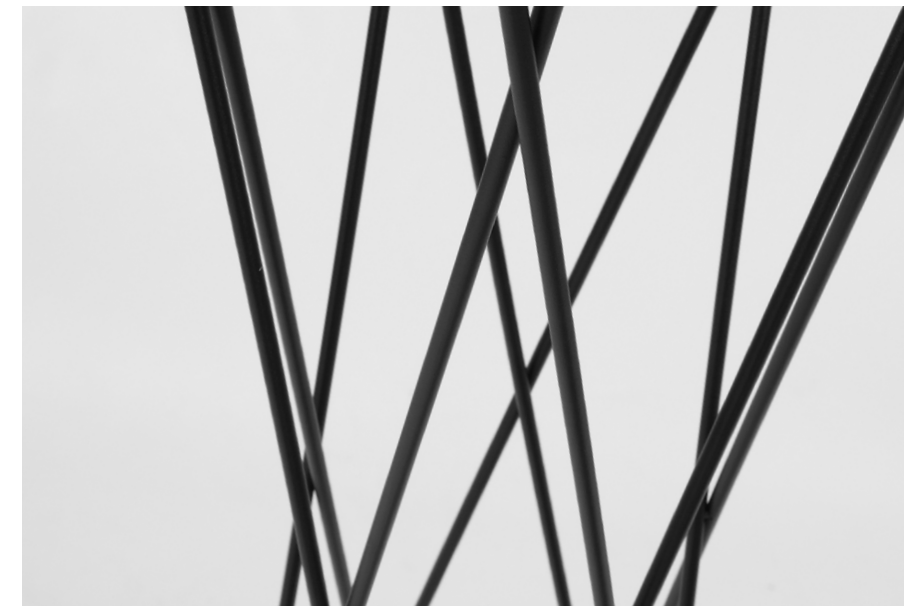
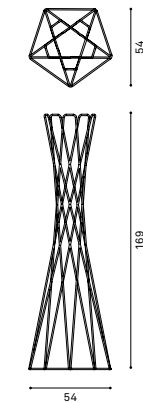

# Tree

DESIGN ROBERT BRONWASSER

The Tree coat stand forms part of Cascando's Nature series: a range of light-hearted elements. Tree is a stable, freestanding coat stand which can hold as many as 16 coats. Made of lacquered MDF with pegs in white grey.

Der Tree Garderobenständer ist Teil der Nature-Serie von Cascando: eine Reihe spielerischer Elemente. Tree ist ein stabiler, frei stehender Kleiderständer, der Platz für mindestens 16 Mäntel bietet. Hergestellt aus lackiertem MDF, mit Knöpfen in Grauweiß.



## MATERIAL AND FINISH

Laquered MDF, grey white powdercoated aluminium hooks

## COLOURS

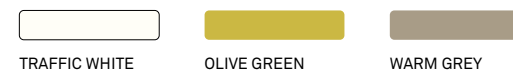

## DIMENSIONS (CM)

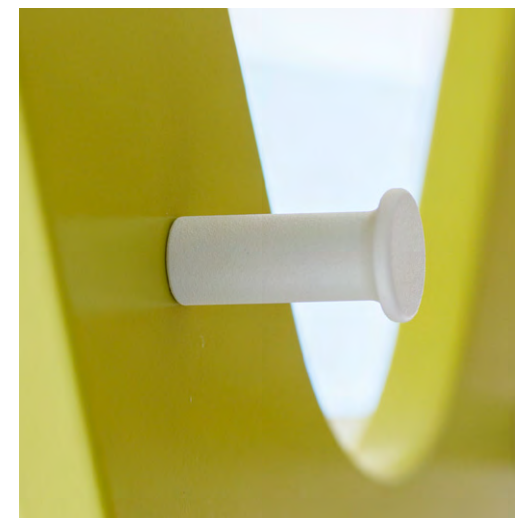
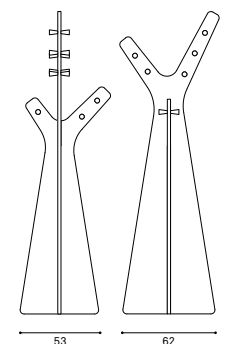



# Bend

DESIGN PETER VAN DE WATER

Bend consists of bent metal uprights which are elegantly connected by aluminium pegs. Coats can be hung on the carefully rounded ends of the strips or on the tree pegs. Bend is available in fresh white, in yellow, red and rugged grey.

Bend besteht aus gebogenen Metallstreifen, die elegant mit Aluminiumknöpfen verbunden sind. Die Mäntel werden über das sorgfältig abgerundete Ende des Streifens oder an die Aluminiumknöpfe gehängt. Bend ist in frischem Weiß, in Gelb, Rot und solidem Grau erhältlich.

## MATERIAL AND FINISH

Powder coated steel uprights, powder coated aluminium pegs

## COLOURS



TRAFFIC WHITE



SIGNAL YELLOW



ANTHRACITE GREY



FLAT RED

## DIMENSIONS (CM)

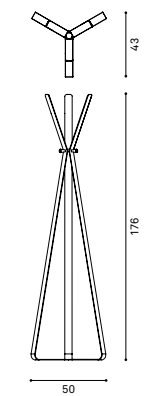

# Pole

DESIGN ROBERT BRONWASSER

Pole is a friendly and elegant steel coat stand. Pole can hold eight to ten coats, matching coat hangers are separately available. Play with the available colours, to give Pole a completely different look: from fresh and cheerful to minimalist and elegant.

Pole ist ein freundlicher und eleganter Garderobenständer aus Stahl. Pole kann acht bis zehn Mäntel tragen; dazu passende Kleiderbügel sind separat erhältlich. Spielen Sie mit den verfügbaren Farben, um Pole ein völlig anderes Erscheinungsbild zu verleihen: von frisch und fröhlich zu minimalistisch und elegant.

## MATERIAL AND FINISH

Powder coated steel

## COLOUR FRAME



TRAFFIC WHITE



TRAFFIC BLACK



WARM GREY

## DIMENSIONS (CM)

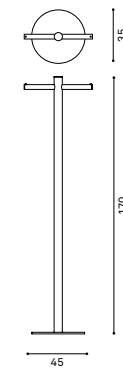

## ADDITIONAL

Matching coat hanger: Pole hanger

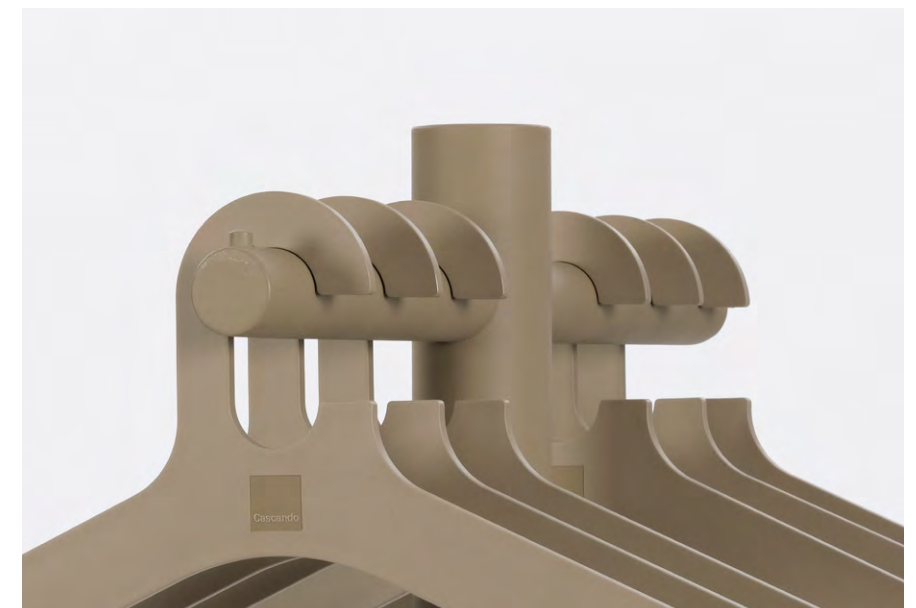

# Bamboo

DESIGN PETER VAN DE WATER





# Bamboo

DESIGN PETER VAN DE WATER

Bamboo, made of steel or oak, is colourful and cheerful. Play with the colours and varieties to create the optimal wardrobe for your project. By sliding the hook upwards, adjusting the rubber O-ring and clicking the hook back into position, you can easily adjust the five hooks on each upright.

Bamboo, aus Stahl oder Eiche, ist bunt und fröhlich. Spielen Sie mit den Farben und Ausführungen, um die optimale Garderobe für Ihr Projekt zu entwerfen. Indem Sie den Haken nach oben schieben, den Gummi O-Ring nach Wunsch versetzen und den Haken wieder in seine Position zurück klicken, können die fünf Haken an jedem Ständer leicht verstellt werden.

## MATERIAL AND FINISH

Oak or powder coated steel upright, polyamide hooks, powder coated steel base

## COLOURS BASE AND UPRIGHT



GREY WHITE



TRAFFIC BLACK



DARK GREEN

## COLOURS HOOK



TRAFFIC WHITE



LIGHT GREY



OLIVE GREEN

## DIMENSIONS (CM)

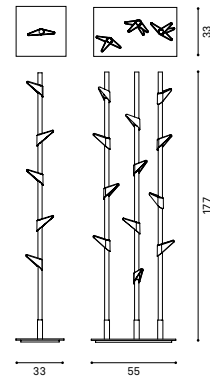

# Kendo

DESIGN PETER VAN DE WATER

Iconic coat stand designed with a simple starting point: carefully crafted oak sticks that are beautifully arranged at an expressive angle, each side in symmetry. The refined connection between the sticks shows the greatest attention to detail. For that personal touch, Kendo can be configured with connecting screws in either matt black or brass.

Das Design des Garderobenständers Kendo ist schlicht: sorgsam handgearbeitete Eichenstäbe, schön symmetrisch in expressiven Winkeln angeordnet. In den eleganten Verbindung zwischen den Stäben zeigt sich die Liebe zum Detail. Kendo kann je nach persönlicher Vorliebe mit Verbindungsschrauben in Mattschwarz oder Messing anfertigt werden.

## MATERIAL AND FINISH

Lauquered oak wood

## COLOURS



NATURAL



BLACK

## DIMENSIONS (CM)

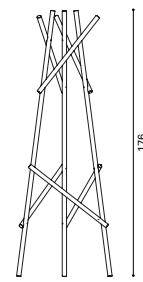
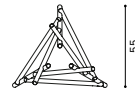

63

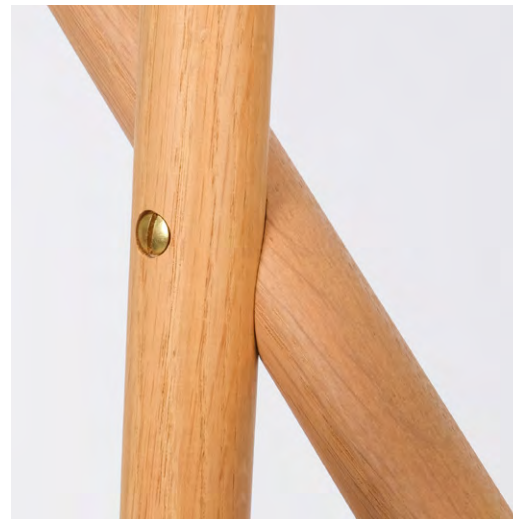

# Fuse

DESIGN PETER VAN DE WATER

Fuse is all about the merger of uprights in oak with carefully rounded coat hooks in steel. Coats can be hung on the large coat hooks or on the smaller hooks in between. Colour combinations make it possible to apply Fuse in various interiors, from colourful to minimalist. A stable coat stand with a sturdy look.

Fuse ist ein Garderobenständer aus Eiche mit schön abgerundeten Kleiderhaken aus Stahl. Dank der großen Haken und den kleineren Haken dazwischen bietet er besonders viel Platz für Jacken und Mäntel. Es sind verschiedene Farbkombinationen möglich, sodass ein Fuse in jede Einrichtung passt. Eine stabile Garderobe mit robuster Ausstrahlung.



CASCANDO

## MATERIAL AND FINISH

Oak wooden uprights, powder coated steel crown and hooks

## COLOURS UPRIGHT



## COLOURS STEEL PARTS

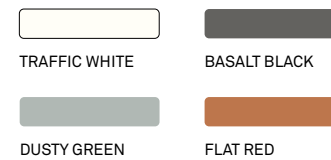

## DIMENSIONS (CM)

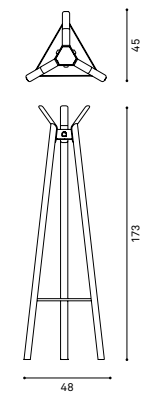

# Patio

DESIGN ROBERT BRONWASSER

Patio elements can be equipped with coat hooks or hangers. They are available in single freestanding versions, in connected and foldable versions. Always mobile, always flexible.

Patio Elemente können mit Kleiderhaken oder Kleiderbügel ausgestattet werden. Sie sind in einzelnen freistehenden, in festverbundenen und scharnierbaren Ausführungen erhältlich. Immer mobil, immer flexibel.

## MATERIAL AND FINISH

Powder coated aluminum frame, bar and coathooks

## COLOURS



## ADDITIONAL

Matching coat hanger: Pole hanger  
Coat hook: R20 coat hook

## DIMENSIONS (CM)

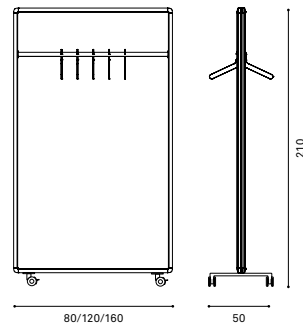

CASCANDO



# Round20 Oak Single

DESIGN ROBERT BRONWASSER

Round20 Single series is a beautiful lined wooden coat rack with room for hooks and hangers. It can also be combined with all the other accessories available in the Round20 series. The wooden frame comes in natural oak, black or white. The frames are available in several widths and can also be joined together.

Round20 Single Serie ist eine wunderschön aus Holz geformte Garderobe für Kleiderbügel und Kleiderhaken. Sie kann auch mit allen anderen Zubehören der Round20 Serie kombiniert werden. Die Rahmen gibt es in Eiche Natur, Schwarz und Weiß. Round20 Single ist in verschiedenen Breiten lieferbar und kann verkettet werden.



CASCANDO

## MATERIAL AND FINISH

Natural or lacquered wooden uprights, casters with brakes, powder coated aluminium bars and hooks

## COLOURS UPRIGHTS



NATURAL OAK

WHITE



BLACK

## COLOURS TUBES



LIGHT GREY

TRAFFIC WHITE



TRAFFIC BLACK

## WARDROBE

## DIMENSIONS (CM)

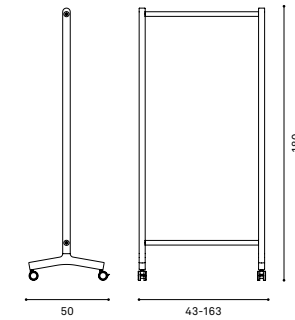

## ADDITIONAL

Matching coat hanger: Pole hanger

Coat hook: R20 coat hook



217

# Round20 Oak Double

DESIGN ROBERT BRONWASSER

The Round20 Double element offers double hanging capacity. The Round20 Double is available in various widths and can also be joined together. The wooden uprights are available in natural oak, black and white, and can be provided with hooks or coat hangers.

Das Round20 Double Element bietet doppelte Aufhängekapazität. Round20 Double ist in verschiedenen Breiten lieferbar und kann verkettet werden. Die Elemente sind in Eiche Natur, in Schwarz und Weiß lieferbar und können mit Garderobenhaken oder Kleiderbügeln bestückt werden.

## MATERIAL AND FINISH

Natural or lacquert wooden uprights, casters with brakes, powder coated aluminium bars and hooks

## COLOURS FRAME



## COLOURS TUBES



## DIMENSIONS (CM)

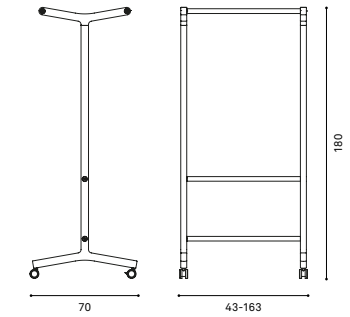

## ADDITIONAL

Matching coat hanger: Pole hanger  
Coat hook: R20 coat hook



# Round20 Alu

DESIGN ROBERT BRONWASSER

The Round20 Alu has an aluminium upright and a steady steel base with casters equipped with brakes. The uprights are available in matt white, aluminium grey and black. The horizontal bars offer plenty of space for coat hooks and hangers. Round20 Alu elements are available in various widths and can be perfectly combined with all the functionality of the Round20 series.

Round20 Alu hat Aluminiumständer und ein Untergestell aus Stahl mit Rollen (bremsbar). Die Ständer sind lieferbar in Weiß, matt, Alugrau und Schwarz. Die Aluminiumstangen bieten viel Platz für Garderobenhaken und Kleiderbügel. Round20 Alu Elemente sind lieferbar in mehreren Breiten und ausgezeichnet kombinierbar mit allen Funktionen der Round20 Serie.

## MATERIAL AND FINISH

Powder coated aluminium uprights and bars, powder coated steel base, casters with brakes

## COLOURS FRAME AND BAR

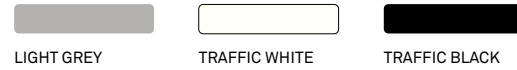

## DIMENSIONS (CM)

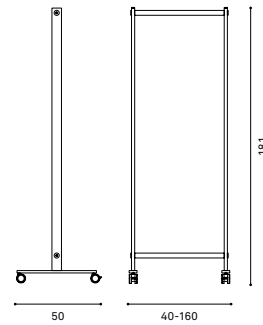

## ADDITIONAL

Matching coat hanger: Pole hanger

Coat hook: R20 coat hook



# Focus

DESIGN GERALD BRANDSTÄTTER

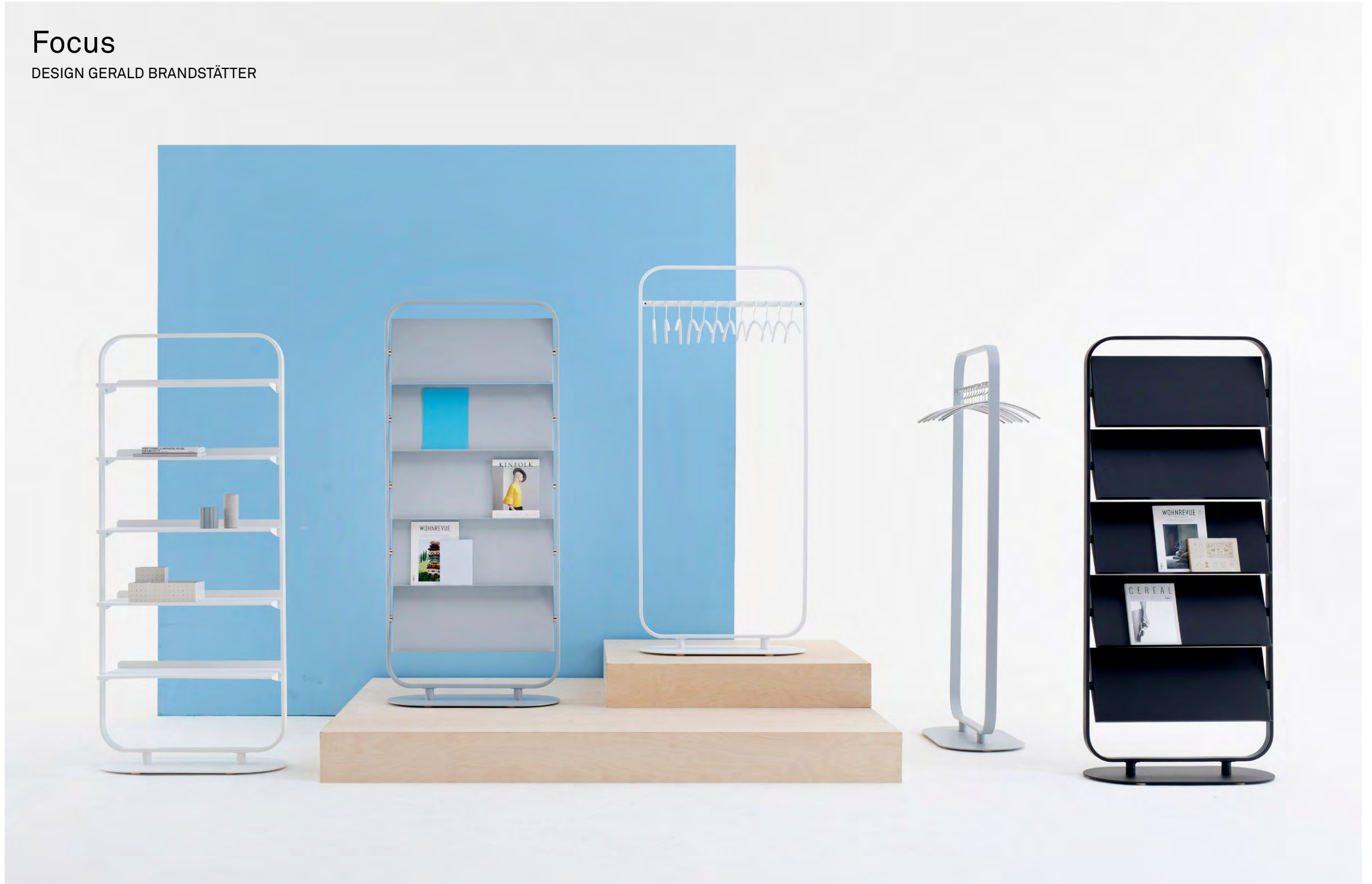



# Focus

DESIGN GERALD BRANDSTÄTTER

The rounded frame and base of Focus are made of steel. Timeless, high-quality and modern, it is available in matt white, black or silver grey. As the horizontal aluminium bar is grooved, the coats hang at regularly spaced intervals.

Der abgerundeten Rahmen und der Fuß des Fokus sind aus Stahl. Zeitlos, hochwertig und modern. Lieferbar in Weiß, matt, Schwarz oder Silbergrau. Da die Garderobenstange mit Rillen versehen ist, hängen die Jacken im gleichen Abstand zueinander.

## MATERIAL AND FINISH

Powder coated steel upright,  
powder coated aluminium horizontal bar

## COLOURS

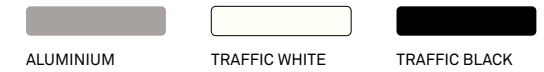

## DIMENSIONS (CM)

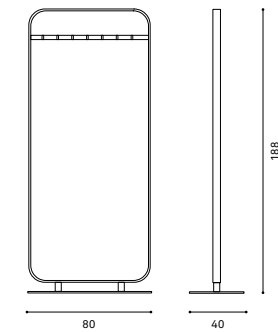

## ADDITIONAL

Matching coat hanger: Chrome hanger





## Standtogether

DESIGN ONNO DE KNEGT

Hidden casters make the minimalistic Standtogether wardrobe easy to move around. The horizontal bar comes with twelve grooves, ensuring that the coats hang neatly in a row. The bar is also available without grooves, for example for use with closed hangers or more than twelve hangers.

Unsichtbare Schwenkrollen machen das Verschieben der minimalistischen Standtogether Projektgarderobe einfach. Die Garderobenstange ist mit zwölf Rillen versehen. Die Jacken hängen so ordentlich in einer Reihe. Die Stange ist auch ohne Rillen lieferbar, z.B. für die Verwendung mit geschlossenen Bügeln oder für mehr als zwölf Bügeln.

### MATERIAL AND FINISH

Polished aluminium bar, powder coated aluminium uprights, powder coated steel base

### COLOUR



ALUMINIUM

### DIMENSIONS (CM)

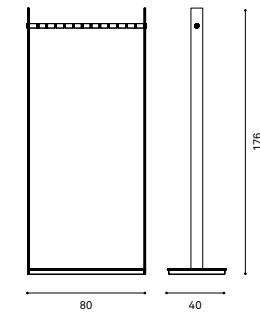

### ADDITIONAL

Matching coat hanger: Chrome hanger



# Flow Large

DESIGN MARLEEN VALSTAR

Flow Large has fourteen sturdy hooks with additional small hooks beneath them. As a result, this coat stand can hold a large number of coats. Flow Large is attractive, yet highly practical. The steel base ensures optimal stability. The crown, pole and stable steel base are coated in matt white or black.

Flow Large hat vierzehn kräftige Haken mit darunter zusätzlichen Aufhängern. Dadurch bietet der Garderobenständer Platz für viele Jacken. Flow Large ist attraktiv und zugleich sehr praktisch. Der stählerne Fuß sorgt für optimale Stabilität. Die Krone, Stange und der stabile Fuß aus Stahl sind Weiß, matt oder Schwarz lackiert.



## MATERIAL AND FINISH

Powder coated steel hooks, uprights and base

## COLOURS



## DIMENSIONS (CM)

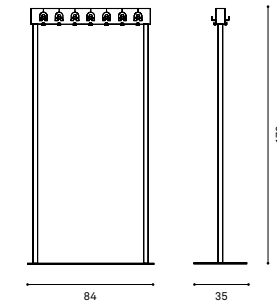



CASCANDO

## Forest

DESIGN ROBERT BRONWASSER

Forest, part of Cascando's Nature series, can be provided with hooks, coat hangers or a combination of the two. There is a good choice of widths. For extra capacity, the element can be expanded to include multiple uprights.

Forest, Teil der Nature-Serie von Cascando, kann nach Wunsch mit Garderobenhaken, Kleiderbügeln oder einer Kombination aus beiden ausgestattet werden. Sie haben die Wahl zwischen verschiedenen Breiten. Für zusätzliche Kapazitäten kann das Element mit mehreren Ständern erweitert werden.

### MATERIAL AND FINISH

Lacquered MDF uprights, powder coated bars

### COLOURS FRAME



### DIMENSIONS (CM)

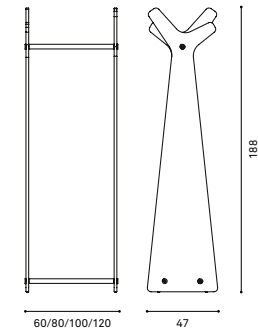

### ADDITIONAL

Matching coat hanger: Pole hanger

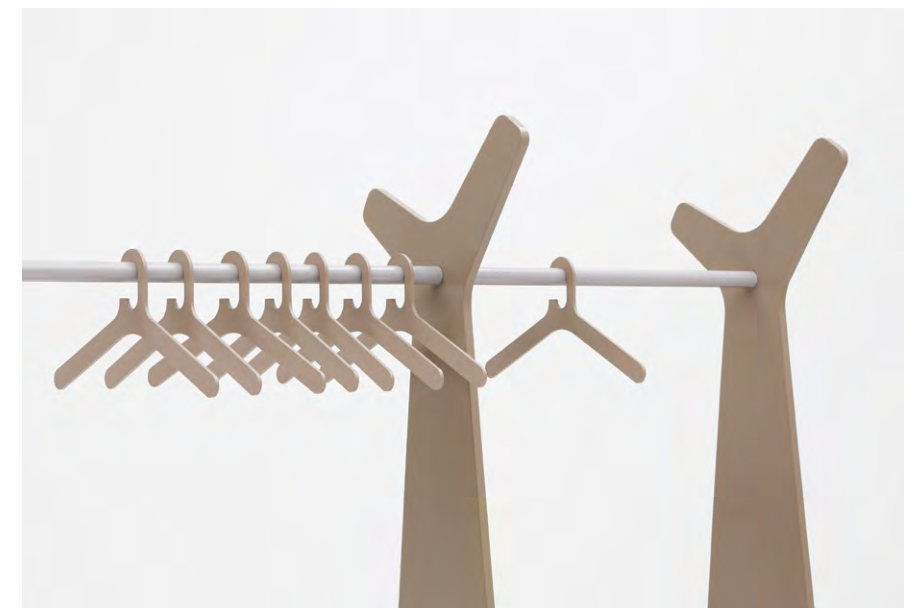

# Pillow Space

DESIGN ROBERT BRONWASSER

Pillow Space wardrobes offer two different ways of storing coats. On the outside, by coat hooks on the panels, or on the inside of the space divider. It is also possible to combine the internal and external storage. Optionally the internal storage space can be closed by a door.

Pillow Space Garderobe Elemente bieten zwei verschiedene Möglichkeiten Mäntel auf zu bewahren. An der Außenseite, mittels Mantelhaken auf den Paneelen, oder innerhalb des Raumteilers. Beide Optionen sind auch zu kombinieren. Der Stauraum kann auf Wunsch mit einer Türe versehen werden.

## MATERIAL AND FINISH

Upholstered MDF panels, powder coated steel base provided with casters with brakes, powder coated aluminium pegs, powder coated steel bar

## FABRICS

See our wide range of fabrics in chapter Fabrics

## ACOUSTIC PROPERTIES

Standard or premium, attenuation and absorption

## DIMENSIONS (CM)

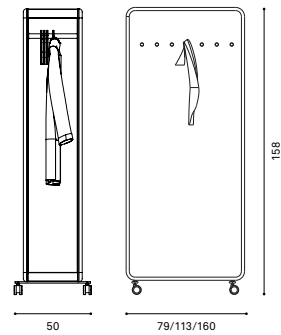

## ADDITIONAL

Matching coat hanger: Pole hanger



# Hangon 1-2-3 double

DESIGN DE KNEGT & VAN DE WATER

The Hangon wardrobe series comes in several different versions – the Hangon 1, 2 or 3. Their hooks are equipped with either one, two or three grooves. Hangon Double is the wide version, offering double capacity. The back panels come in aluminium, the hook in polished aluminium.

Hangon Wandgarderoben gibt es in verschiedenen Ausführungen: Hangon 1, 2 oder 3, ausgestattet mit einer, zwei oder drei Rillen. Hangon Double ist die breite Version und bietet doppelte Kapazität. Die Wandpaneele gibt es in Aluminium, die Haken in poliertem Aluminium.



CASCANDO

## MATERIAL AND FINISH

Powder coated aluminium,  
hooks in polished aluminium

## COLOUR BACKPANEL



ALUMINIUM

## COLOUR HOOKS



POLISHED ALU

## DIMENSIONS (CM)

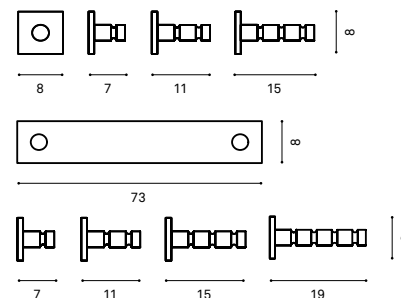

235

# Stick

DESIGN ROBERT BRONWASSER

In combination with the matching Pole coat hangers, Stick exudes pure simplicity. Stick is made of coated aluminium and is suitable for either one or two hangers.

In Kombination mit dem dazu passenden Kleiderbügel Pole strahlt Stick reine Schlichtheit aus. Stick ist gefertigt aus pulverbeschichtetem Aluminium und eignet sich für einen oder zwei Bügel.

## MATERIAL AND FINISH

Powder coated aluminium

## COLOURS



## DIMENSIONS (CM)

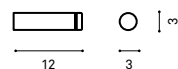

## ADDITIONAL

Matching coat hanger: Pole hanger



CASCANDO

# Clickon

DESIGN ONNO DE KNEGT

Clickon is a magnetic wall hook for use on steel walls or steel cabinets. The wardrobe comes in either a stylish combination of polished and anodized aluminium, or in a powerful powder coating. Clickon is equipped with either one, two or three grooves for hangers.

Clickon ist eine magnetische Wandgarderobe für den Einsatz auf Stahlwänden oder Stahlschränken. Die Garderobe wird entweder in einer stilvolle Kombination von poliertem und eloxiertem Aluminium, oder in einer leistungsstarken Pulverbeschichtung geliefert. Clickon ist mit einer, zwei oder drei Rillen für Bügel ausgestattet.

## MATERIAL AND FINISH

Anodised back panel and polished aluminium bar  
Powder coated back panel and bar

## COLOUR ALUMINIUM



## COLOUR POWDER COATED



## DIMENSIONS (CM)

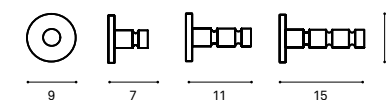

## ADDITIONAL

Matching coat hanger: Chrome hanger



237

## Hangon 7-12

DESIGN ONNO DE KNEGT &  
PETER VAN DE WATER

Hangon 7 has a transparent and clear shape. The polished aluminium wardrobe bar comes with grooves but, if desired, also without. The wardrobe is available in two widths and is suitable for seven to twelve hangers. Hangon 12 also has an extended rear wall offering additional coat hooks. The hat shelf is made of hardened glass.

Hangon 7 hat eine transparente und klare Form. Die Garderobenstange aus poliertem Aluminium ist mit Rillen versehen, aber auch ohne erhältlich. Die Wandgarderobe ist in zwei Breiten lieferbar und für sieben bis zwölf Kleiderbügel geeignet. Hangon 12 hat eine verlängerte Rückwand mit zusätzlichen Garderobenhaken. Die Hutablage ist aus gehärtetem Glas.

### MATERIAL AND FINISH

Polished aluminium horizontal bar, hardened glass plate, powder coated aluminium panels

### COLOURS



ALUMINIUM

### DIMENSIONS (CM)

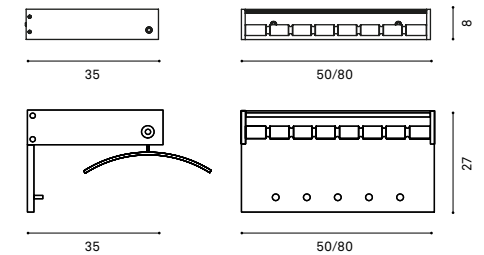

### ADDITIONAL

Matching coat hangers: Chrome hanger







# Flow

DESIGN MARLEEN VALSTAR

The Flow coat hook is available with one, three or seven hooks. The elements can be used individually as well as in series. Flow is available in matt white and matt black.

Flow Wandgarderobe gibt es mit einem, drei oder sieben Haken. Die Elemente können sowohl einzeln als auch in Serie verwendet werden. Flow ist in matt Weiß und matt Schwarz lieferbar.

## MATERIAL AND FINISH

Powder coated steel

## COLOURS

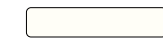

TRAFFIC WHITE



TRAFFIC BLACK

## DIMENSIONS (CM)

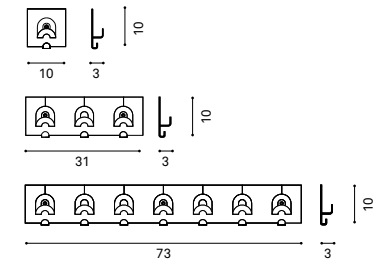

# Bend

DESIGN PETER VAN DE WATER

The Bend coat hook is part of the well-known Bend coat stand series. Coats can be hung on the carefully rounded ends of the strip or on the aluminium peg.

Der Bend Kleiderhaken ist Teil der gut bekannten Bend Garderobenständer Serie. Mäntel kann man einfach auf die sorgfältig abgerundeten Enden des Hakens oder auf den Knopf aus Aluminium aufhängen.

## MATERIAL AND FINISH

Powder coated steel strip,  
powder coated aluminium peg

## COLOURS



TRAFFIC WHITE



SIGNAL YELLOW



ANTHRACITE GREY



FLAT RED

## DIMENSIONS (CM)

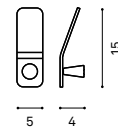

CASCANDO

# Branch

DESIGN ROBERT BRONWASSER

Branch is a wardrobe that is part of the Nature series. Each wardrobe element is made of lacquered MDF and has five coat hooks. You can create your own branch by combining different shapes and colours.

Branch ist die Wandgarderobe aus der Nature-Serie. Branch besteht aus lackiertem MDF und hat fünf Mantelhaken. Kombinieren Sie verschiedene Zweige und Farben und Sie entwerfen Ihren eigenen Zweig.

## MATERIAL AND FINISH

Laquered MDF, grey white powdercoated  
aluminium hooks

## COLOURS



TRAFFIC WHITE



OLIVE GREEN



WARM GREY

## DIMENSIONS (CM)

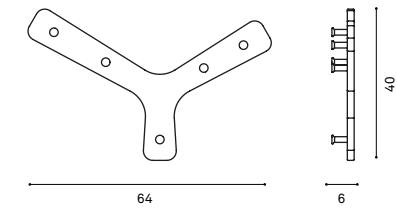

243

# Bamboo Wall

DESIGN PETER VAN DE WATER

The white polyamide hooks of Bamboo are easily adjustable: slide the hook up, adjust the rubber O-ring, and then just click the hook back into place. Bamboo is available in two lengths. The short version has three hooks, the long version has five.

Die Haken aus mattweißem Kunststoff sind leicht verstellbar: schieben Sie die Haken nach oben, verstellen Sie den O-Ring aus Gummi und klicken Sie den Haken wieder in seine Position zurück. Bamboo ist in zwei Längen lieferbar. Die kurze Ausführung hat drei Haken, die lange Ausführung fünf.

## MATERIAL AND FINISH

Oak wood upright, polyamide hooks

## COLOUR HOOKS



TRAFFIC WHITE

## DIMENSIONS (CM)

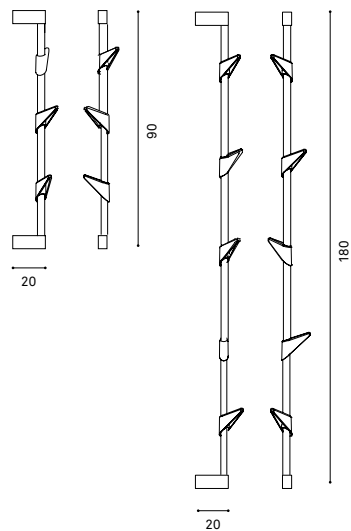



CASCANDO

## Pole

DESIGN ROBERT BRONWASSER

Pole hangers have a friendly round shape. The design fits with many different wardrobes. Pole hangers are available in several contemporary colours.

Pole Kleiderbügel haben eine freundliche runde Form. Das Design passt zu vielen verschiedenen Garderoben. Pole Kleiderbügel sind in verschiedenen Farben lieferbar.

### MATERIAL AND FINISH

Polyamide

### COLOURS

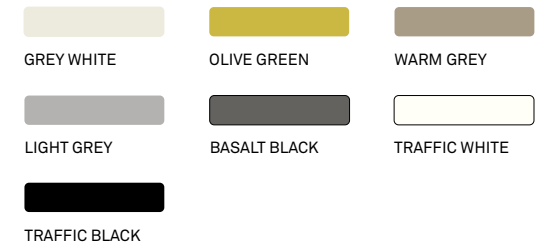

### DIMENSIONS (CM)

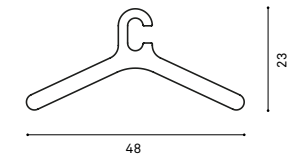

### ADDITIONAL

Maximum bar ø: 32 mm



# Lean On

DESIGN PETER VAN DE WATER

The Lean on hangers have a slim, graceful shape. They are made of matt stainless steel.

Die Lean on Kleiderbügel haben eine schlanke, anmutige Form. Sie werden aus Edelstahl gefertigt.

## MATERIAL AND FINISH

Stainless steel

## DIMENSIONS (CM)

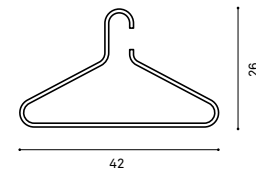

## ADDITIONAL

Maximum bar ø: 36 mm

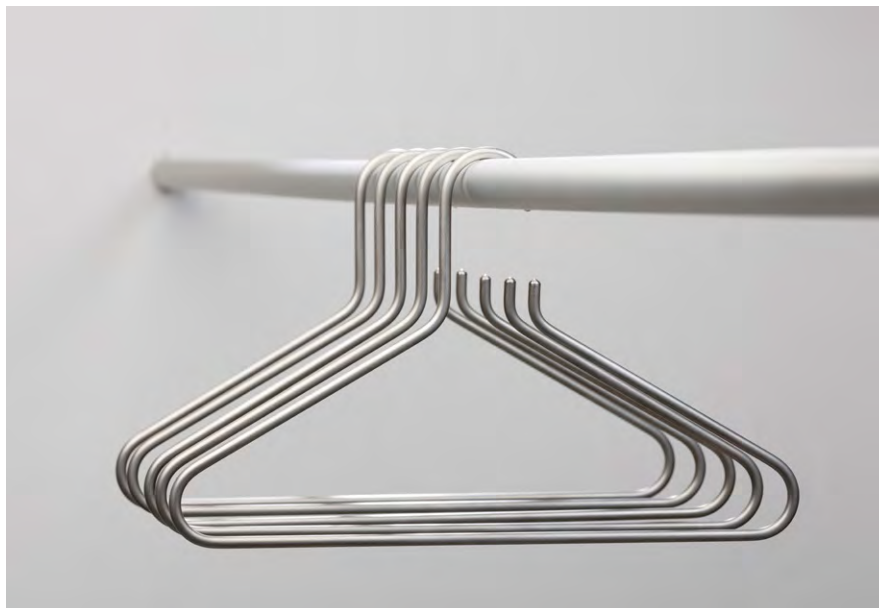

CASCANDO

# Chrome

DESIGN CASCANDO STUDIO

Chrome coat hangers are made of steel and have a chrome finish. They are also available with a matt powder coated finish in either black or white. The simple design is highly practical and perfectly matches the Standalone, Standfree, Standtogether and Hangon series.

Die Kleiderbügel Chrome sind aus verchromtem Stahl gefertigt. Auch sind sie pulverbeschichtet in matt Schwarz oder matt Weiß erhältlich. Die Gestaltung ist praktisch im Gebrauch und passt perfekt zu Standalone, Standfree, Standtogether und zur Hangon-Serie.

## MATERIAL AND FINISH

Chromed or powder coated steel

## COLOURS



## DIMENSIONS (CM)

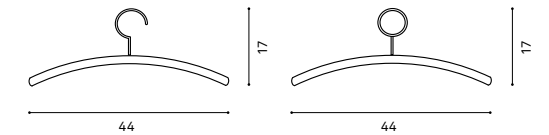

## ADDITIONAL

Maximum bar ø: 36 mm

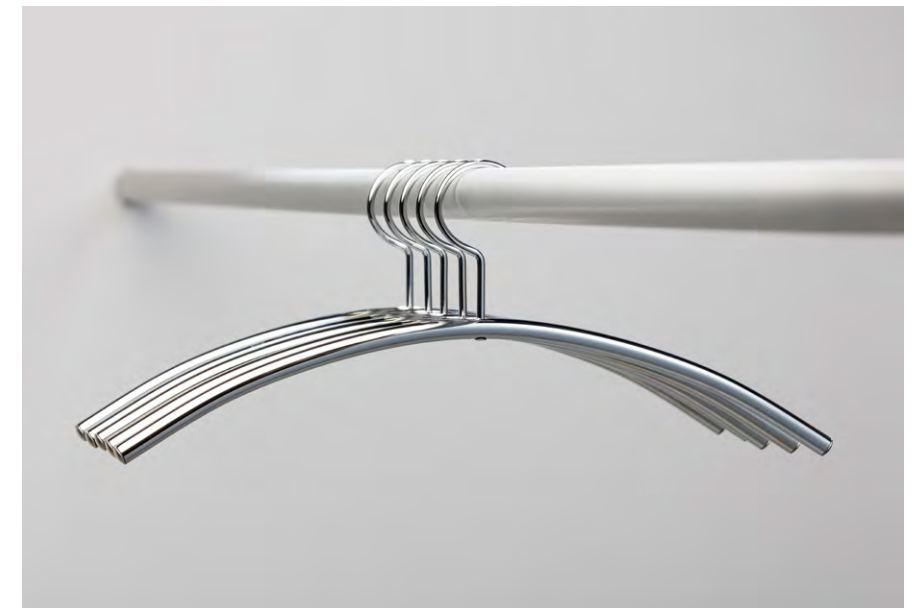

249

# Plus

DESIGN ROBERT BRONWASSER

Plus coat hangers have refined, soft rounded shapes. The hangers are suitable for all kind of coats and include an extra loop for scarves and shawls. They are available in five contemporary colours. Plus hangers are suitable for use with a tube with a diameter of 32 mm or less.

Die Kleiderbügel aus der Plus-Serie haben elegante runde Formen. Sie haben eine Querstange für Schals und sind für alle Arten von Mänteln und Jacken geeignet. Sie sind in fünf aktuellen Farben erhältlich. Plus-Kleiderbügel können an Stangen mit einem Durchmesser von bis zu 32 mm aufgehängt werden.

## MATERIAL AND FINISH

Polyamide

## COLOURS

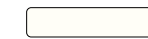

TRAFFIC WHITE



SILK GREY



DUSTY GREEN



BASALT BLACK



GREY BLUE LIGHT

## DIMENSIONS (CM)

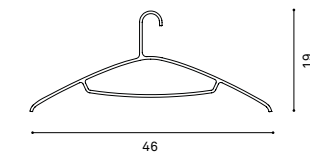

## ADDITIONAL

Maximum bar  $\varnothing$ : 32 mm



# Display and storage

DISPLAY THE FAVE MAGAZINES AND BROCHURES IN FUNCTIONAL DESIGN ELEMENTS THAT MESSAGE STYLE AND ENERGY.

Mags, corporate brochures, papers, a product hand out, they all represent your culture of work. Create a stand, a happy library. Inform. And share the news you care about.

Zeitschriften, Firmenbroschüren, Zeitungen, ein Produktblatt, alles repräsentiert Arbeitskultur. Kreiere einen Stand, eine fröhliche Bibliothek. Informell. Und teile die Neuigkeiten die dir wichtig sind.



Scan to discover  
Display and storage

WALL MOUNTED MOBILE

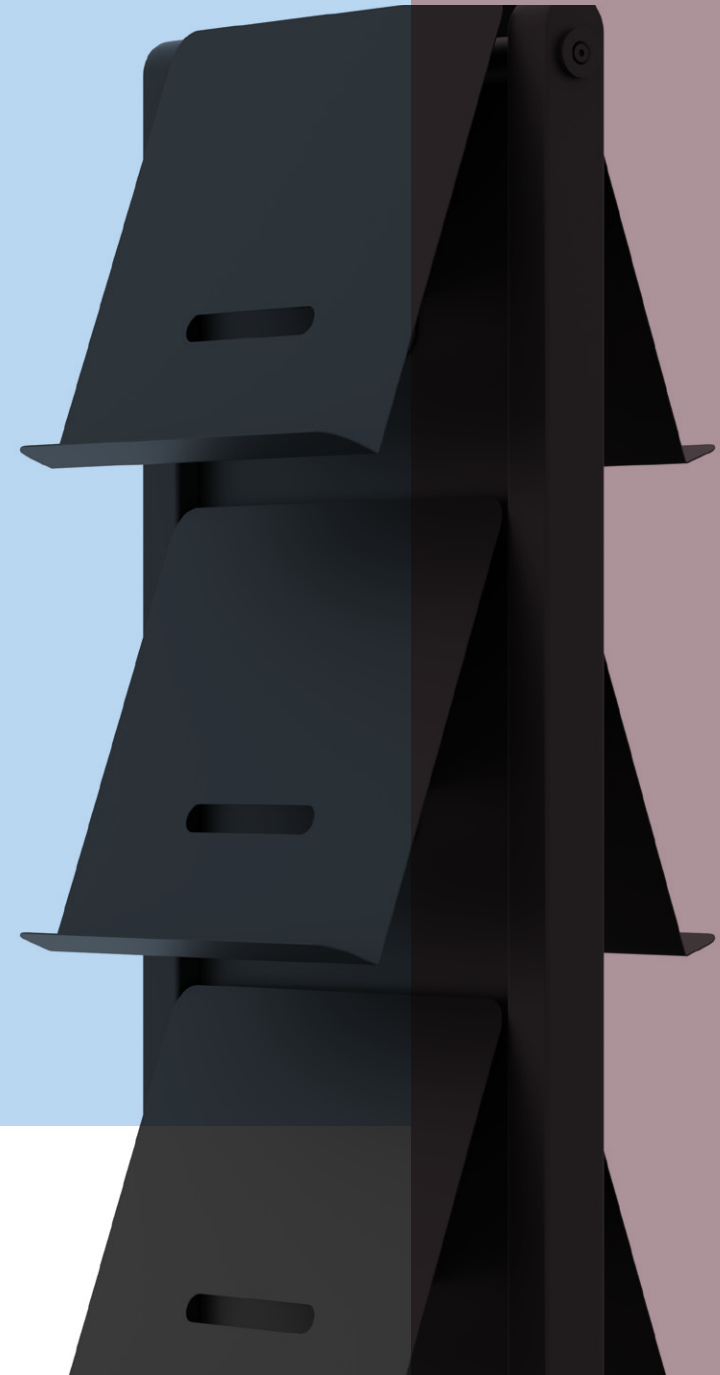

# Patio

DESIGN ROBERT BRONWASSER





# Patio

DESIGN ROBERT BRONWASSER

Patio elements can be equipped with magazine trays (upholstered back panel as option), with shelves and storage trays. They are available in single freestanding version, in connected and foldable versions.

Patio Elemente können mit Zeitschriftenablagen (optional mit gepolsterter Rückwand), mit Fachböden und Stauraum ausgestattet werden. Sie sind in einzelnen freistehenden, in festverbundenen und scharnierbaren Ausführungen erhältlich.



Patio Double elements have wide shelves to store office stuff or personal belongings. Combined with whiteboard or upholstered panels, they offer great functionality.

Patio Double Elemente verfügen über breite Regale zur Aufbewahrung von Bürotensilien oder persönlichen Gegenständen. Kombiniert mit Whiteboard oder gepolsterten Paneelen bieten sie tolle Funktionalität.



CASCANDO



**MATERIAL AND FINISH**

Powder coated aluminum frame, powder coated steel shelves, tray and brochure holder, optional upholstered panel or powder coated steel whiteboard

**ADDITIONAL**

Tray: 12 cm depth, 14 cm height  
 Shelves: 25 cm depth  
 Shelves double: 37 cm depth

**COLOURS**



TRAFFIC BLACK



GREY WHITE

**FABRICS**

See our wide range of fabrics in chapter Fabrics

**DIMENSIONS (CM)**

Magazine holder

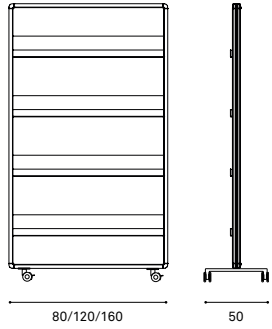

Magazine holder with panel

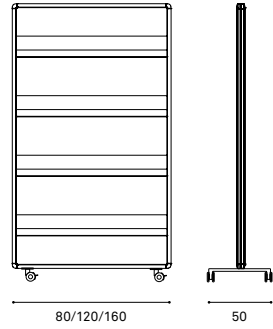

Trays

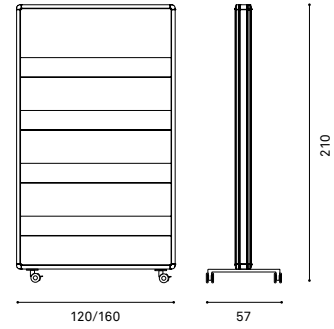

Shelves

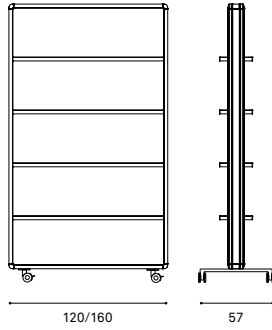

Double

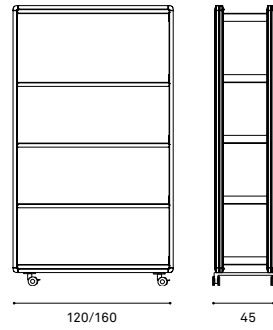

Double with panel

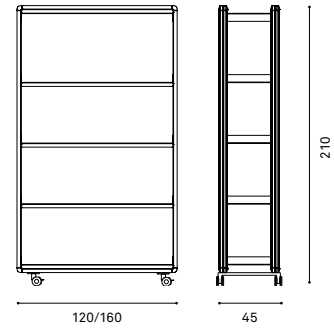

# Round20 Oak

DESIGN ROBERT BRONWASSER

The solid oak frame is available in natural oak, black or white. The brochure holders are available in two widths and can also be joined together. Round20 frames can also be equipped with coat hangers, coat hooks, whiteboard and acoustic panels. Mobile and flexible.

Der Rahmen aus massiver Eiche ist in natürlicher Eiche, Schwarz oder Weiß erhältlich. Die Prospekt Halter sind in zwei verschiedenen Breiten lieferbar und können auch verkettet werden. Round20 Rahmen können auch mit Kleiderhänger, Mantelknöpfe, aber auch Whiteboards und akustische Paneele ausgestattet werden. Mobil und flexibel.

## MATERIAL AND FINISH

Natural or lacquered wooden uprights, casters with brakes, powder coated bars, powder coated steel brochureholders on MDF panel

## COLOURS FRAME

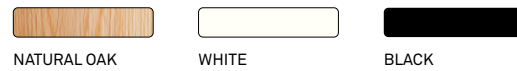

## COLOURS BROCHURE HOLDERS

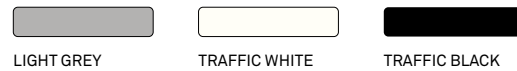

## DIMENSIONS (CM)

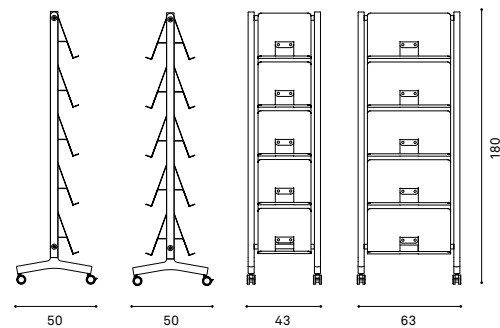

## ADDITIONAL

Brochure holder depth: 39 mm





## Round20 Alu

DESIGN ROBERT BRONWASSER

The Round20 Alu element has aluminium uprights and a steel base. Panels are available in two widths and can be mounted double-sided. By placing multiple panels side by side, the element width is unlimited. Colours white, black and alu-grey.

Das Alu-Element hat Ständer aus Aluminium und ein Gestell aus Stahl. Die Elemente gibt es in zwei Breiten, die doppelseitig montiert werden können. Durch die Aufstellung mehrerer Elemente nebeneinander ist die Breite des Systems unbegrenzt. Farben: Weiß, Schwarz und Alusilber.

### MATERIAL AND FINISH

Powder coated aluminium uprights, powder coated steel base, casters with brakes, powdercoated steel brochureholders on MDF panel

### COLOURS



### DIMENSIONS (CM)

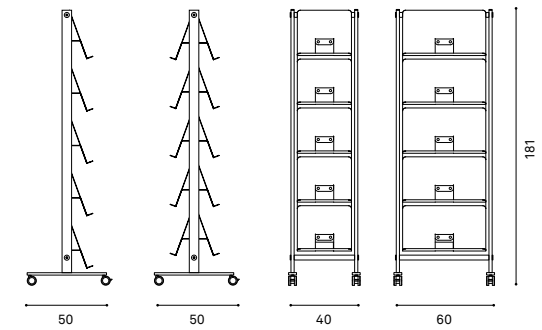

### ADDITIONAL

Brochure holder depth: 39 mm



# Focus

DESIGN GERALD BRANDSTÄTTER

Focus is characterized by its round shapes. The shelves can be mounted in horizontal or slanted position and offer ample space for brochures or books. All parts are made of steel and available in a matt white, black or silver-grey powder coating.

Focus wird gekennzeichnet durch seine abgerundete Form. Focus hat Tablare, die horizontal oder schräg montiert werden können. Sie bieten ausreichend Platz für Broschüren oder Bücher. Alle Teile sind aus Stahl gefertigt und pulverbeschichtet in matt Weiß, Schwarz oder Silbergrau erhältlich.



## MATERIAL AND FINISH

Powder coated steel

## COLOURS

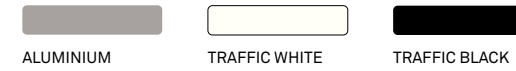

## DIMENSIONS (CM)

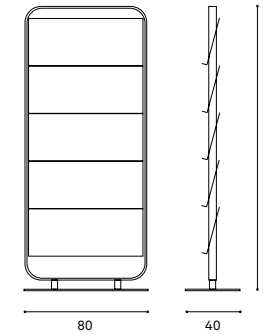

## ADDITIONAL

Brochure holder depth: 35 mm



# Flexible

DESIGN ONNO DE KNEGT & MARLEEN VALSTAR



# Flexible

DESIGN DE KNEGT & VALSTAR

Flexible can be used as brochure holder, as a bookshelf or as a storage system. The panels are adjustable and can be mounted in either a horizontal or slanted position. There is a single, double, and large version. Timeless design, ready to represent you.

Flexible kann als Prospekthalter, als Bücherregal oder als Aufbewahrungssystem verwendet werden. Die Paneele sind verstellbar und können sowohl schräg, als auch horizontal angebracht werden. Es gibt eine Single, Double und Large Version. Zeitloses Design, bereit, großartige Arbeit zu präsentieren.





MATERIAL AND FINISH

Powder coated steel base and shelves,  
powder coated aluminium uprights

ADDITIONAL

Matching coathanger: Chrome hanger

COLOUR FRAME



DIMENSIONS (CM)

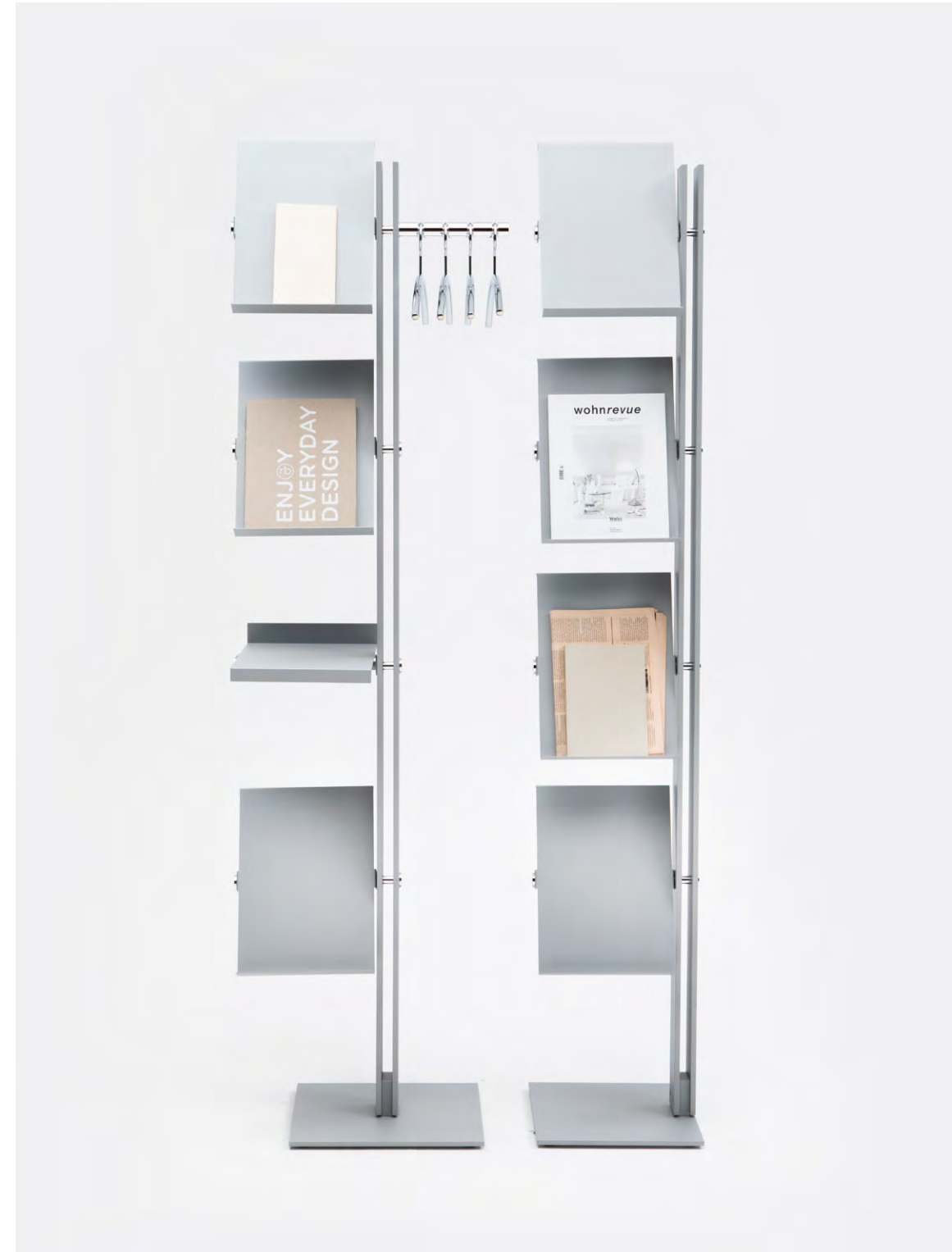
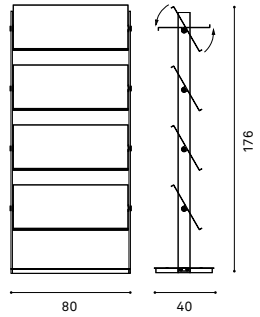
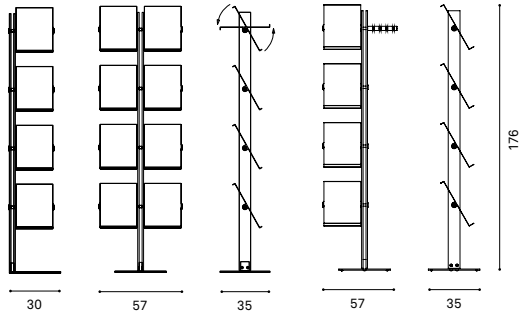

# Pillow Space

DESIGN ROBERT BRONWASSER

Pillow Space offers plenty space to present and store magazines or brochures. They can be placed either on the front side on shelves with straps or on the short side. There is storage space behind the brochure holders on the short side. Pillow Space is mobile and offers visual privacy and sound absorption.

Pillow Space bietet viel Platz zum Präsentieren und Aufbewahren von Zeitschriften oder Broschüren. Sie können entweder stirnseitig auf Regalböden mit Laschen oder an der kurzen Seite platziert werden. Hinter den Prospekthaltern an der kurzen Seite befindet sich Stauraum. Pillow Space ist mobil und bietet Sichtschutz und Schallabsorption.

## MATERIAL AND FINISH

Upholstered MDF panels, powder coated steel base provided with casters with brakes, powder coated shelves and brochure holders, lacquered wooden magazine holder with recycled yarn straps

## FABRICS

See our wide range of fabrics in chapter Fabrics

## ACOUSTIC PROPERTIES

Standard or premium, attenuation and absorption

## DIMENSIONS (CM)

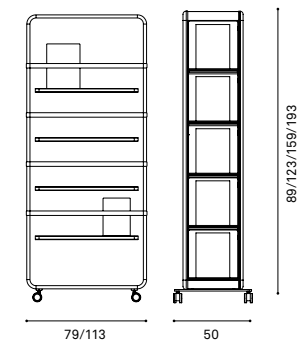

## ADDITIONAL

Brochure holder steel depth: 33 mm  
Magazine holder MDF depth: 50 mm





## Round20 Wall

DESIGN ROBERT BRONWASSER

The Round20 brochure holders for wall mounting are available as single brochure holders or as a MDF panel containing five above each other. They are both available in two different widths and three colours; white, black and alugrey. The product can be provided with magnets for magnetic mounting on steel walls. Brochure holder depth: 39 mm.

Die Round20 Prospekthalter zur Wandmontage sind als einzelne Prospekthalter oder als MDF Paneel mit fünf Prospekthaltern übereinander angeordnet erhältlich. Beide sind in zwei verschiedenen Breiten und drei Farben lieferbar; Weiß, Schwarz und Alusilber. Das Produkt kann auch mit Magneten zur magnetischen Befestigung auf Stahlwänden geliefert werden. Tiefe Prospektablage: 39 mm.

### MATERIAL AND FINISH

Powdercoated steel brochureholders, MDF panel with melamine finish

### COLOUR



### DIMENSIONS (CM)

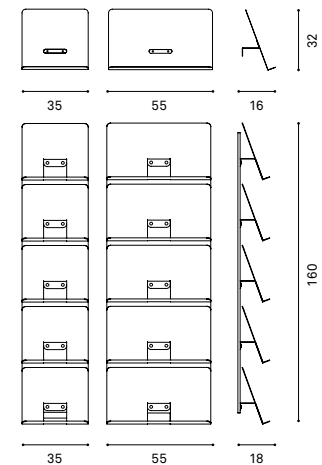

# Video furniture

Travel the world in an instant by using furniture solutions that enable mobile video conferencing (and gaming). Looking each other in the eye sometimes needs a digital connection. Show it, do not tell. Team up, zoom in, facilitate working apart together. Flexible, mobile - always ready.

Reise im Handumdrehen durch die Welt, indem du Möbel verwendest die Mobile Video Konferenzen ermöglichen (und Computerspiele). Für den Augenkontakt benötigt man manchmal eine digitale Verbindung. Zeigen, nicht Erzählen. Bilde ein Team, zoom ein, unterstütze getrenntes Zusammenarbeiten. Flexibel, mobil – immer einsatzbereit.



Scan to discover  
Video meeting furniture



# Patio

DESIGN ROBERT BRONWASSER

Patio elements are perfect to keep your video screens. There are various configurations, open elements with shelves or trays for additional storage or with upholstered panel for a clean office look. They are available in freestanding version or foldable version.

Patio Elemente sind perfekt geeignet für Videomeetings oder Präsentationen. Es gibt verschiedene Konfigurationen, offene Elemente mit Regalen oder Behältern für zusätzlichen Stauraum oder mit gepolstertem Paneel für einen aufgeräumten Bürolook.



CASCANDO

## MATERIAL AND FINISH

Powder coated aluminum frame, powder coated steel shelves, tray and brochure holder, upholstered panel

## COLOURS



## LCD SUPPORT

Options see price list

## DIMENSIONS (CM)

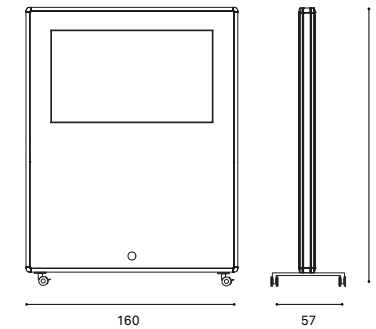

## ADDITIONAL

Tray or shelf is optional, for all options see Patio overview on page 50-51

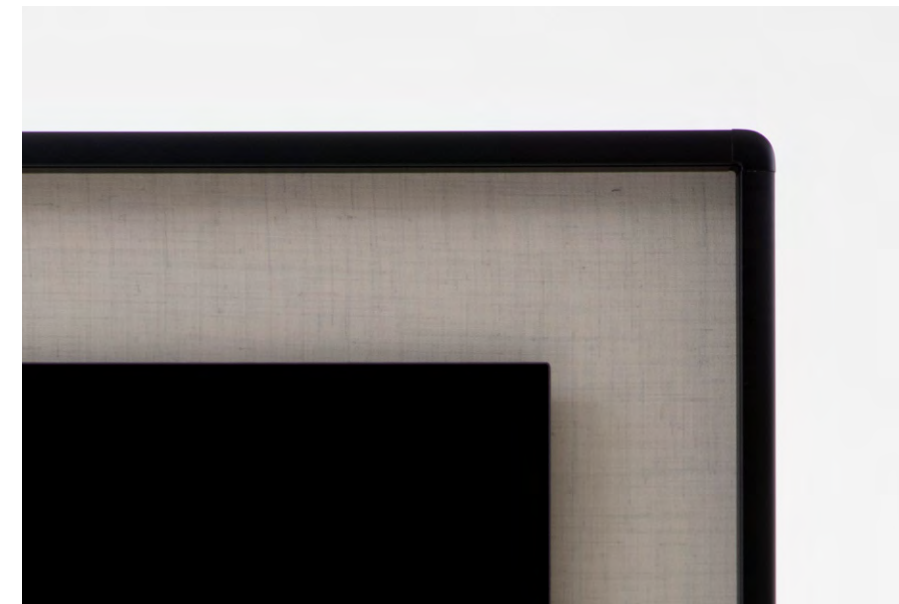

# Pillow Space

DESIGN ROBERT BRONWASSER

Pillow Space is a perfect tool for presentations, Teams- or Zoom-meetings. It can be equipped with LCD or OLED screens up to 65 inch. The upholstered panels are sound absorbing, ensuring both visual and acoustic privacy. A perfect tool for every agile workspace.

Pillow Space ist ein perfektes Tool für Präsentationen, Teams- oder Zoom-Meetings. Es kann mit LCD- oder OLED-Bildschirmen bis 65 Zoll ausgestattet werden. Die gepolsterten Paneele sind schallabsorbierend und sorgen sowohl für visuelle als auch akustische Privatsphäre. Ein perfektes Werkzeug für jeden agilen Arbeitsbereich.

## MATERIAL AND FINISH

Upholstered fabric panels, powder coated steel base, casters with brakes

## FABRICS

See our wide range of fabrics in chapter Fabrics

## ACOUSTIC PROPERTIES

Standard, attenuation and absorption

## LCD SUPPORT

Options see price list

## VIDEO MEETING FURNITURE

## DIMENSIONS (CM)

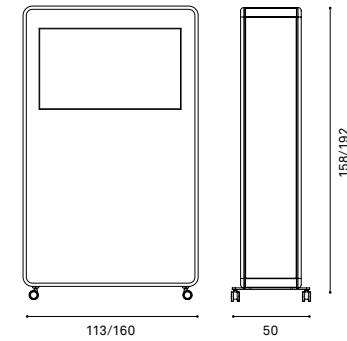

CASCANDO



283

# Trunk

DESIGN ROBERT BRONWASSER

Trunk is a mobile space divider which can be equipped with LCD or OLED screens. It is ideal for in-house presentations or video meetings. Trunk has a leather handle and can easily be moved from space to space. The upholstered panels absorb sound and improve both visual and acoustic privacy during meetings.

Trunk ist ein mobiler Raumteiler, der mit LCD- oder OLED-Bildschirmen ausgestattet werden kann. Es ist ideal für interne Präsentationen oder Videokonferenzen. Trunk hat einen Ledergriff und kann leicht von Raum zu Raum bewegt werden. Die gepolsterten Paneele absorbieren Schall und verbessern sowohl die visuelle als auch die akustische Privatsphäre bei Besprechungen.

## MATERIAL AND FINISH

Wooden frame upholstered with foam and fabric, casters with brakes, leather handle, aluminium powder coated coat hook, felt remote controller holder

## FABRICS

See our wide range of fabrics in chapter Fabrics

## ACOUSTIC PROPERTIES

Standard or premium, attenuation and absorption

## LCD SUPPORT

Options see price list

## DIMENSIONS (CM)

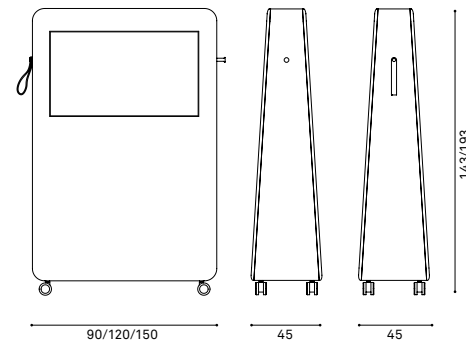

# Whiteboards

COLLECT IDEAS ON MOBILE WHITEBOARDS AND SHARE THE VALUE OF PROGRESSIVE THINKING BY CONNECTING MINDS.

Every idea is worth a whiteboard. Open it up. Add brown paper sessions, judge mood boards, mark the perfect pay-off. Show the fruits of thought and illustrate the visions.

Jede Idee ist ein Whiteboard wert. Stelle es dir vor. Füge Brown-paper-sessions hinzu, beurteile Mood-boards, markiere das perfekte Resultat. Zeige die Früchte der Gedankengänge und illustriere Ziele.



Scan to discover  
Whiteboards

WALL MOUNTED MOBILE







## Patio

DESIGN ROBERT BRONWASSER

Patio elements can be equipped with steel whiteboards. Single- or double sided, as you wish. They are available in single freestanding versions, in connected and foldable versions. Agile and highly functional.

Patio Elemente können mit Whiteboards aus Stahl ausgestattet werden. Je nach Wunsch ein- oder doppelseitig. Sie sind in einzelnen freistehenden, in festverbundenen und schmierbaren Ausführungen erhältlich. Agil und funktional.





CASCANDO

**MATERIAL AND FINISH**

Powder coated aluminum frame, powder coated magnetic steel whiteboard, with optional a strip of panel fabric, uni décor grey or oak

**COLOURS**



**DIMENSIONS (CM)**

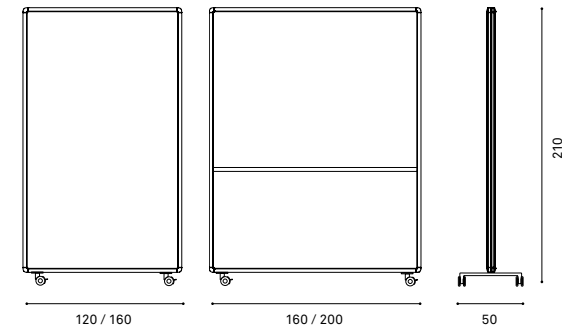

**ADDITIONAL**

The 180 / 200 whiteboards are standard open at the bottom, fabric panel or decor panel is optional  
Optional accessories: magnetic felt pocket for storing markers, markers, eraser, flipchart holder and magnets



291

# Pillow Space

DESIGN ROBERT BRONWASSER

The Pillow Space whiteboards are available with glass and steel whiteboards. Glass whiteboards are mounted on the fabric surface. Steel whiteboards cover the total surface. Both whiteboards are magnetic. Markers can be stored in a friendly felt pocket. Pillow Space is mobile and also offers visual privacy and sound absorption.

Die Pillow Space Whiteboards sind mit Glas- und Stahl-Whiteboards erhältlich. Glas-Whiteboards werden auf der Stoffoberfläche montiert. Whiteboards aus Stahl bedecken die gesamte Oberfläche. Beide Whiteboards sind magnetisch. Marker können in einer freundlichen Filztasche aufbewahrt werden. Pillow Space ist mobil und bietet zudem Sicht- und Schallschutz.



**MATERIAL AND FINISH**

Upholstered MDF panels, powder coated steel base provided with casters with brakes, enamelled steel sheet whiteboard or magnetic glass whiteboard

**FABRICS**

See our wide range of fabrics in chapter Fabrics

**ACOUSTIC PROPERTIES**

Standard or premium, attenuation and absorption

**DIMENSIONS (CM)**

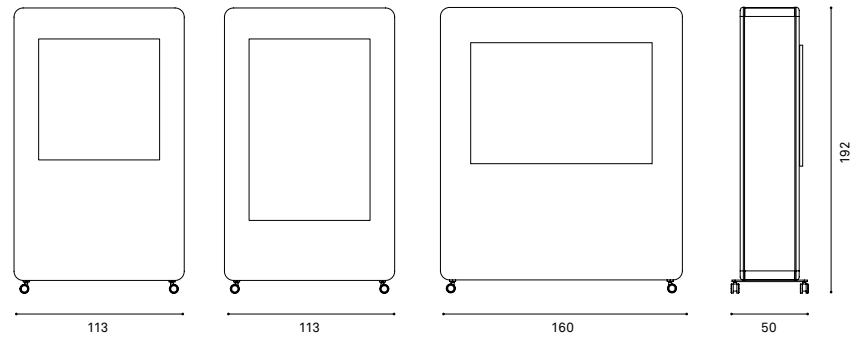
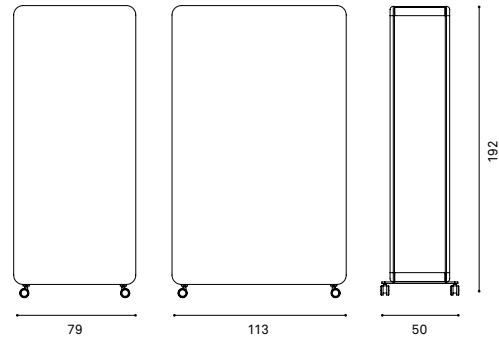

**ADDITIONAL**

For these Pillow Space whiteboards there is a wide range of options as shown on page 61



# Trunk

DESIGN ROBERT BRONWASSER

Trunk is a multifunctional space divider which can be equipped with a whiteboard or even a second whiteboard on the rear. The whiteboards are made of high-quality steel plate, come in various sizes and are suitable for magnetic accessories. A friendly felt pocket for marker pens is included. The leather strap and casters make Trunk mobile and flexible in use. Trunk is sound absorbing.

Trunk ist ein multifunktionaler Raumteiler, der mit einem Whiteboard oder sogar einem zweiten Whiteboard auf der Rückseite ausgestattet werden kann. Die Whiteboards sind aus hochwertigem Stahlblech gefertigt, in verschiedenen Größen erhältlich und für magnetisches Zubehör geeignet. Eine freundliche Filztasche für Markierungsstifte ist im Lieferumfang enthalten. Der Lederriemen und die Rollen machen Trunk mobil und flexibel einsetzbar. Trunk ist schallabsorbierend.

## MATERIAL AND FINISH

Wooden frame upholstered with foam and fabric, casters with brakes, leather handle, aluminium powder coated coat hook, felt marker holder, enamelled steel sheet whiteboard

## FABRICS

See our wide range of fabrics in chapter Fabrics

## ACOUSTIC PROPERTIES

Standard or premium, attenuation and absorption

## DIMENSIONS (CM)

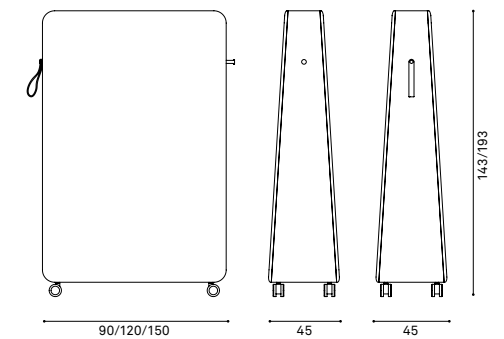

# Round20 Oak

DESIGN ROBERT BRONWASSER

The solid oak frame is available in natural oak, black or white. They can be fitted with high-quality steel whiteboards in various widths. There are single sided or double sided versions or combinations with whiteboard on the front and acoustic panel on the rear. Markers can be stored in a friendly felt pocket.

Der Rahmen aus massiver Eiche ist in natürlicher Eiche, Schwarz oder Weiß erhältlich. Sie können mit hochwertigen Whiteboards aus Stahl in verschiedenen Breiten ausgestattet werden. Es gibt einseitige oder doppelseitige Versionen oder Kombinationen mit Whiteboard auf der Vorderseite und Akustikplatte auf der Rückseite. Marker können in einer freundlichen Filztasche aufbewahrt werden.

## MATERIAL AND FINISH

Natural or lacquert wooden uprights, casters with brakes, MDF base with enameled steel whiteboard sheet

## FABRICS

See our wide range of fabrics in chapter Fabrics

## COLOURS FRAME

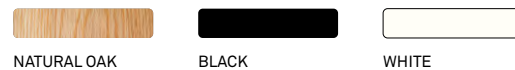

NATURAL OAK

BLACK

WHITE

## DIMENSIONS (CM)

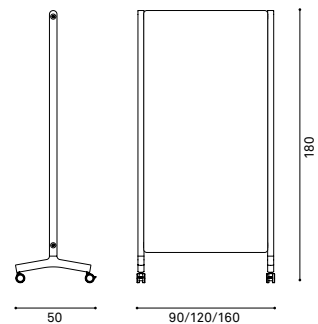

## Round20 Alu

DESIGN ROBERT BRONWASSER

The Round20 aluminium frame with solid steel base is available in matt black or white. They can be fitted with high-quality steel whiteboards in various widths. There are single sided or double sided whiteboards or combinations with acoustic panel on the rear. Markers can be stored in a friendly felt pocket.

Der Round20 Aluminiumrahmen mit solidem Stahlfuß ist in mattem Schwarz oder Weiß erhältlich. Sie können mit hochwertigen Whiteboards aus Stahl in verschiedenen Breiten ausgestattet werden. Es gibt einseitige oder doppelseitige Whiteboards oder Kombinationen mit Akustikplatte auf der Rückseite. Marker können in einer freundlichen Filztasche aufbewahrt werden.

### MATERIAL AND FINISH

Powder coated aluminium uprights, powder coated steel base, casters with brakes, MDF base with enameled steel whiteboard sheet

### FABRICS

See our wide range of fabrics in chapter Fabrics

### COLOURS FRAME



### DIMENSIONS (CM)

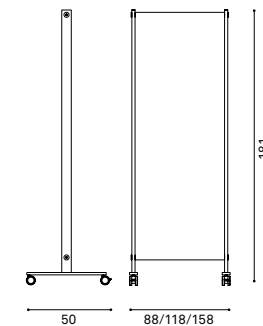

# Pillow Grid

DESIGN ROBERT BRONWASSER

Pillow Grid whiteboards are part of the Pillow series. These magnetic whiteboards have a surface of hardened glass and are available in various sizes. Optional accessories such as a magnetic felt pocket for storing marker pens, a flipchart holder, erasers, markers and magnets complete the design.

Pillow Grid Whiteboards sind Teil der Pillow Serie. Die magnetischen Whiteboards haben eine Oberfläche aus gehärtetem Glas. Die Tafeln gibt es in verschiedenen Größen. Optionelle Accessoires, wie eine magnetisch Filz Tasche für Stifte, einen Flipcharthalter, Wischer, Stifte und Magnete machen das Design komplett.



CASCANDO

## WHITEBOARDS

### MATERIAL AND FINISH

Tempered glass with steel back plate

### MOUNTING

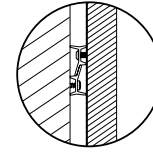

### ADDITIONAL

Optional whiteboard shelf  
Optional accessories: magnetic felt pocket for storing markers, markers, eraser, flipchart holder and magnets

### DIMENSIONS (CM)

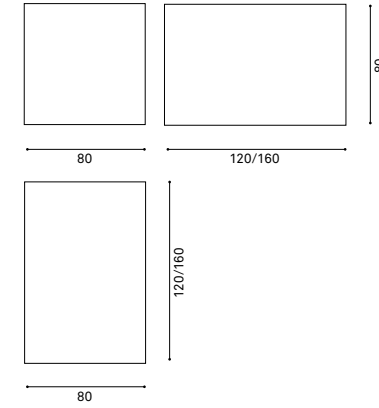

303



# Round20 Wall

DESIGN ROBERT BRONWASSER

The Round20 Wall whiteboards are made of steel. They are magnetic and available in various sizes. Optional accessories such as a magnetic felt pocket for storing marker pens, markers, an eraser, a flipchart holder and magnets complete the design.

Round20 Wall Whiteboards haben eine Oberfläche aus Stahl. Die Tafeln sind magnetisch und in verschiedenen Größen verfügbar. Optionelle Accessoires wie eine magnetisch Filz Tasche für Stifte, ein Flipcharthalter, Wischer, Stifte und Magnete machen das Design komplett.

## MATERIAL AND FINISH

MDF base with enamelled steel sheet whiteboard  
optional: powder coated aluminium marker holder

## MOUNTING

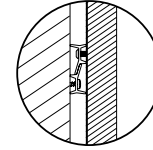

## DIMENSIONS (CM)

Landscape or portrait  
82X112  
82X160  
112x160  
112X112  
152x160

## ADDITIONAL

Optional whiteboard shelf  
Optional accessories: magnetic felt pocket for storing markers, markers, eraser, flipchart holder and magnets



CASCANDO



305

# Planters



Scan to discover  
Planters

INCREASE BIODIVERSITY IN THE OFFICE ECOSYSTEM AND  
ENERGIZE BODY AND MIND BY LANDSCAPING A GREEN WORK  
ENVIRONMENT.

Consider the office as a garden of Eden. Cleaner air, tactile  
barriers, spacious green lanes. Looks nice, works better, feels  
good. So, show your colours. Plant. Choose the green deal.

Stelle dir vor, das Büro wäre der Garten Eden. Reinere Luft,  
tastbare Inseln, großzügige Grünzonen. Sieht toll aus, funktioniert  
besser und fühlt gut. So, zeige deine Farben. Pflanze. Wähle grün.

# Patio

DESIGN ROBERT BRONWASSER

Patio elements can green your office. You can place your plants in the planter trays, on the shelves or hang them on the adjustable planter cable. They are available in single freestanding versions, in connected or foldable versions.

Patio Elemente machen das Büro grüner. Pflanzen können in Pflanzenbehälter oder auf Regale gestellt oder an das in Höhe verstellbare Pflanzenkabel aufgehängt werden. Sie sind in einzelnen freistehenden, in festverbundenen und scharnierbaren Ausführungen erhältlich.

## MATERIAL AND FINISH

Powder coated aluminum frame, powder coated steel trays

## COLOURS



## DIMENSIONS (CM)

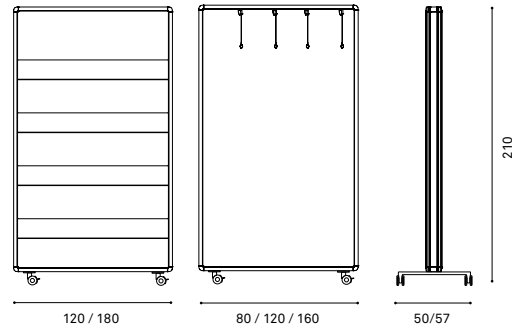

## ADDITIONAL

Tray: 12 cm depth, 14 cm height  
Adjustable hangers up to 2 meter with loop,  
trays 1-4, waterproof inlay is necessary





## Slide

DESIGN PETER VAN DE WATER

Slide is a sculptural element which will add a touch of green to any place. Slide will hold your plants, flowers or even personal belongings. You can simply adjust the height and direction of the pots to create the design that fits your needs. There is also a wall version to create a greenery wall.

Slide ist ein Skulptur- Element, das jedem Ort einen Hauch von Grün verleiht. Slide trägt Ihre Pflanzen, Blumen oder sogar persönlichen Gegenstände. Die Höhe und Richtung der Töpfe kann einfach angepasst werden, um das Design zu erstellen, das den Bedürfnissen entspricht.





CASCANDO

**MATERIAL AND FINISH**

Powder coated steel upright, plastic jars

**COLOURS**

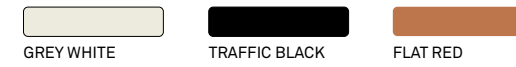

**DIMENSIONS (CM)**

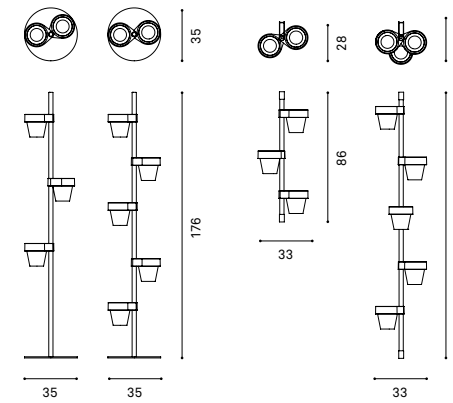

# Rombo

DESIGN EMILIANA DESIGN STUDIO



# Rombo

DESIGN EMILIANA DESIGN STUDIO

The diamond shape of Rombo allows many different configurations. They come in different heights and colours. All the parts are carefully crafted, with superb attention to detail. A rubber insert can be ordered separately. Mix and match all objects to create a living ecosystem.

Die Rautenform von Rombo ermöglicht viele verschiedene Konfigurationen. Es gibt sie in verschiedenen Höhen und Farben. Alle Teile sind sorgfältig verarbeitet, mit viel Liebe zum Detail. Ein Gummi Einsatz kann separat bestellt werden. Mischen und kombinieren Sie alle Objekte, um ein lebendiges Ökosystem zu schaffen.

## MATERIAL AND FINISH

Powder coated steel, waterproof PVC insert

## COLOURS

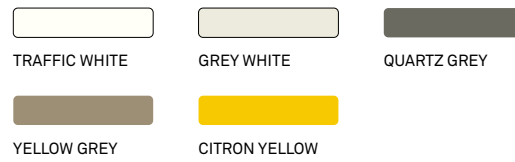

## DIMENSIONS (CM)

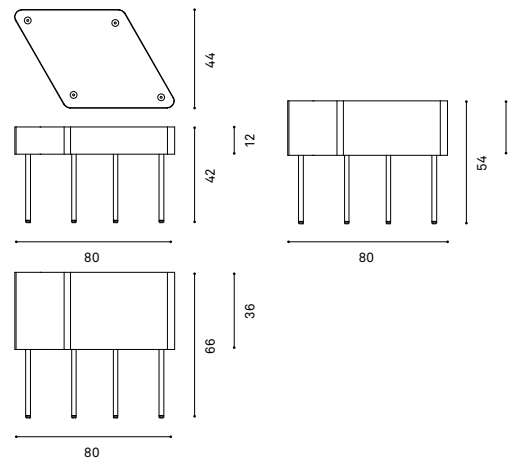

# Pillow Space

DESIGN ROBERT BRONWASSER

Pillow Space planters make the office greener. They also offer visual privacy and absorb sound. They come in various sizes and are always mobile. A rubber insert is included so they are ready to plant.

Pillow Space Pflanzengefäße machen das Büro grüner. Sie bieten auch Sichtschutz und absorbieren Schall. Sie sind in verschiedenen Größen erhältlich und immer mobil. Ein Gummieinsatz ist im Lieferumfang enthalten, damit sie sofort bepflanzt werden können.

## MATERIAL AND FINISH

Upholstered panels, powder coated steel, waterproof PVC insert, casters with brakes

## FABRICS

See our wide range of fabrics in chapter Fabrics

## ACOUSTIC PROPERTIES

Standard or premium, attenuation and absorption

## DIMENSIONS (CM)

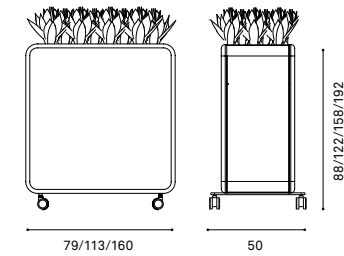

CASCANDO



319



# Umbrella stands

PROTECT PEOPLE FROM ALL THE NASTY WEATHER EFFECTS  
BY INTEGRATING THE ONE SOLID ACCESSORY THAT IS  
CLIMATE RESISTANT.

Snow, rain, storm, a heat wave. Have that broly at hand.  
Functional, iconic, and elegant. A simply way to safeguard that  
original jacket and keep a positive mood.

Schnee, Regen Sturm, eine Hitzewelle. Halte den Schirm bei der  
Hand. Funktional, ikonisch und elegant. Eine einfache Manier  
um Kleidungsstücke zu schützen und die gute Stimmung zu  
bewahren.



Scan to discover  
Umbrella stands

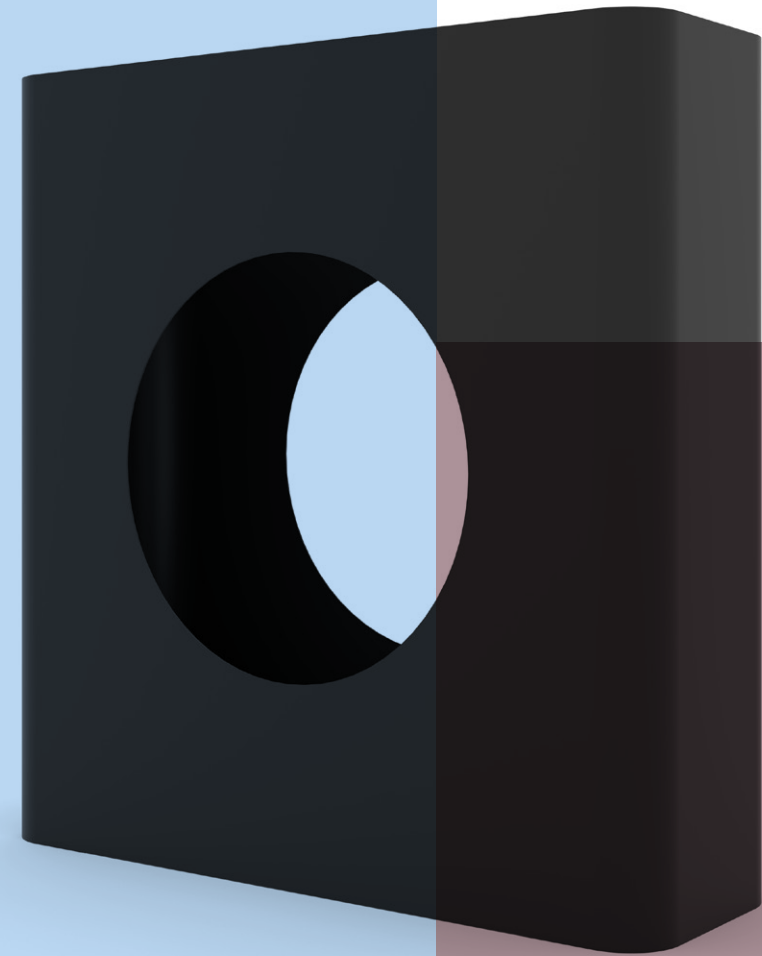

# Flow I

DESIGN MARLEEN VALSTAR

A functional design icon for each entrance. Completely made of steel, seamlessly finished and optionally fitted with an insert container for short umbrellas.

Eine funktionelle Designikone für jeden Eingangsbereich. Vollständig hergestellt aus Stahl, nahtlos verarbeitet und wahlweise erhältlich mit einem Einsatz für Taschenschirme.

## UMBRELLA STANDS

### MATERIAL AND FINISH

Powder coated steel

### COLOURS

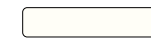

TRAFFIC WHITE



TRAFFIC BLACK



ALUMINIUM

### DIMENSIONS (CM)

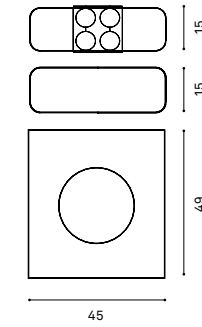

CASCANDO



323



## Square - Flow II

DESIGN MARLEEN VALSTAR

Square a is a sleek, high umbrella stand with clean-cut square corners made of steel. Flow II is a tall umbrella stand with attractive rounded edges. Made of steel with a perfect finish.

Square ist ein schlanker, hoher Schirmständer mit rechten Winkeln. Flow II ist ein hoher Schirmständer mit abgerundeten Ecken. Beide Schirmständer sind aus Stahl gefertigt, und perfekt verarbeitet.

### MATERIAL AND FINISH

Powder coated steel

### COLOURS



TRAFFIC WHITE



ALUMINIUM



TRAFFIC BLACK

### DIMENSIONS (CM)

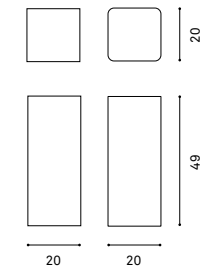

# Flower

DESIGN ROBERT BRONWASSER

Beautifully lined umbrella stand with a holder from PMMA and a stable cast iron base with integrated drip box. Among the large hooks are smaller loop hooks, which are suitable to hang foldable umbrellas.

Wunderschön entworfener Schirmständer mit einem Halter aus Polyamide und einem stabilen Fuß aus Gusseisen mit integrierter Tropfschale. Zwischen den großen Schlaufenhaken befinden sich kleinere Haken für das Aufhängen von Knirpsen.

MATERIAL AND FINISH

Polyamide crown, powder coated steel tube and cast iron base

COLOUR

TRAFFIC BLACK

DIMENSIONS (CM)

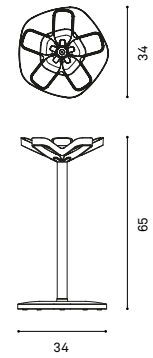

# Paper bins

CREATE A PAPERLESS OFFICE BY LURING EVERY INCH OF PAPER INTO AN ATTRACTIVE WASTE BIN READY FOR RECYCLING.

Paper. It is immortalising our writing. We all use it. Still. And yes, that is taking a ton of trees. A perfect reason to mark the end of every A4 as the start of something new. In the bin.

Papier. Macht Geschriebenes unsterblich. Wir alle verwenden es, noch immer. Und Ja, dies verbraucht Mengen an Bäumen. Ein perfekter Grund um das Ende von jedem A4 als Beginn zu etwas Neuem kenntlich zu machen, im Papierkorb.



Scan to discover  
Paper bins



# Square

DESIGN CASCANDO STUDIO



# Square

DESIGN CASCANDO STUDIO

The waste bins from the Square series have square corners and simple lines. They are meticulously finished in thin-walled steel. Available in three sizes and three colours. Can be supplied with a cover ring if required. Special colours are available on request.

Die Papierkörbe aus der Square-Serie haben gerade Ecken und gerade Linien. Sie werden sorgfältig in dünnwandigem Stahl verarbeitet. Lieferbar in drei Größen und drei Farben. Falls gewünscht mit Abdeckring. Sonderfarben sind möglich.

## MATERIAL AND FINISH

Powder coated steel

## COLOURS



TRAFFIC WHITE



TRAFFIC BLACK



ALUMINIUM

## DIMENSIONS (CM)

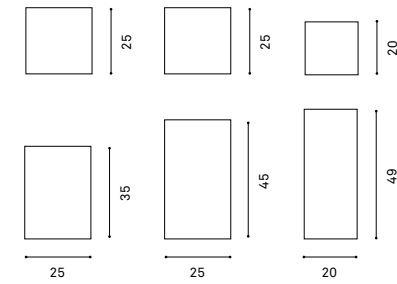

CASCANDO



333



CASCANDO

# Flow

DESIGN CASCANDO STUDIO

Flow waste bins have attractive rounded corners. They are made of steel with a perfect finish. Available in three sizes and three colours. Special colours are available on request.

Flow-Papierkörbe haben attraktive runde Ecken. Sie sind aus Stahl gefertigt und perfekt verarbeitet. Lieferbar in drei Maßen und drei Farben. Sonderfarben sind möglich auf Anfrage.

## MATERIAL AND FINISH

Powder coated steel

## COLOURS



TRAFFIC WHITE



ALUMINIUM



TRAFFIC BLACK

## DIMENSIONS (CM)

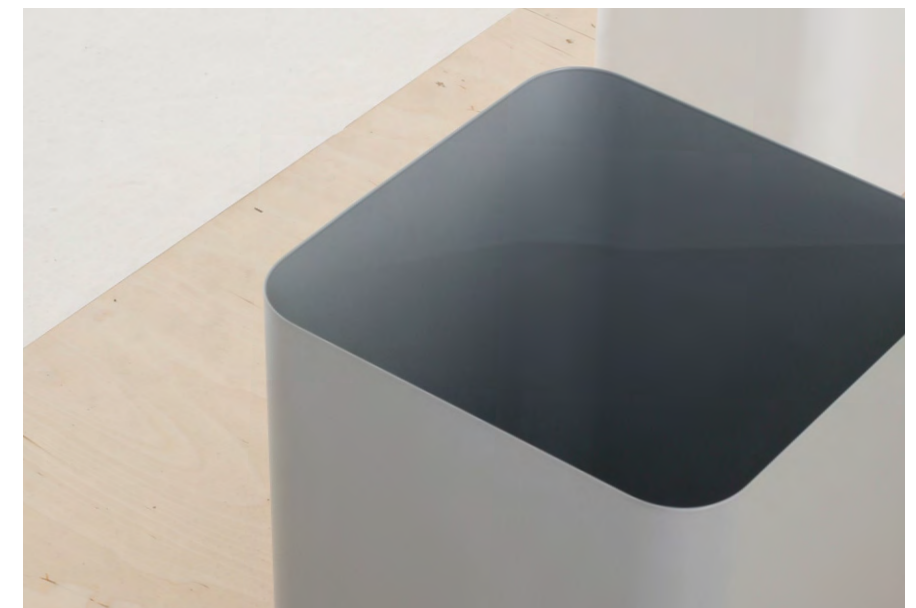
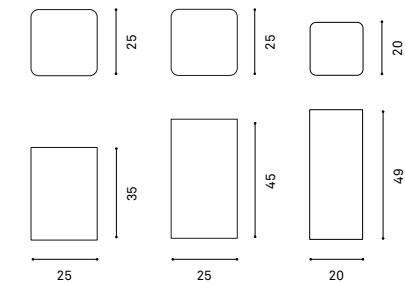

335



# How acoustic furniture can help to improve the comfort of your work.

## SOUND ABSORPTION

### SOUND ATTENUATION

#### Schallschirmung

Sound attenuation may be accomplished by the use of vertical elements, like space dividers, desk- and privacy panels. This technique will isolate sound and prevent the transmission of noise through the space. Sound levels in the space will decrease, while the audibility and clarity of speech improve.

Zur Schallschirmung können vertikale Elemente wie zum Beispiel Raumteiler, Tisch- und Privacy Panele eingesetzt werden. Geräusch wird dadurch isoliert, während zugleich die Schallübertragung durch die Luft verhindert wird. Der Geräuschpegel im Raum nimmt ab, sodass man besser und deutlicher hören kann, was gesagt wird.

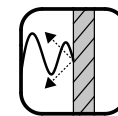

Attenuation

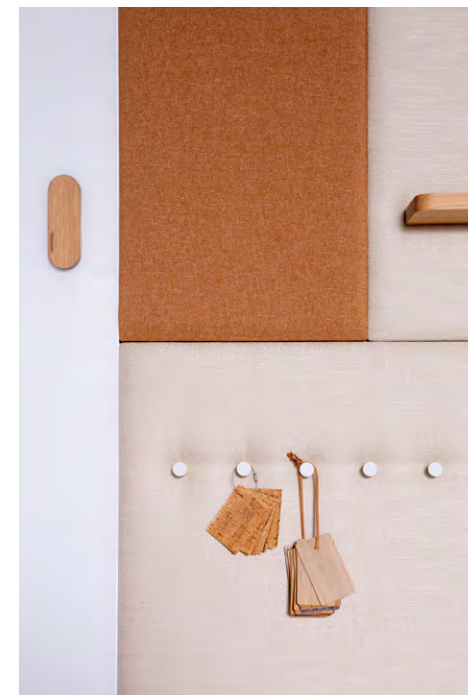

### SOUND ABSORPTION

#### Schallabsorption

Sound absorption can be achieved by applying soft materials with open structures and sufficient thickness. Sound is quickly assimilated by the material and converted into heat, leading to reduced reverberation times. The sound absorption will improve the wellbeing of people using a space.

Durch Verwendung von weichem, offen strukturiertem Material von ausreichender Dicke lässt Schall sich absorbieren. Geräusche werden von einem derartigen Material schnell aufgenommen und in Wärme umgesetzt, was zu kürzeren Nachhallzeiten führt. Das Wohlbefinden der Raumnutzer wird durch die resultierende Schallbegrenzung erheblich verbessert.



Absorption

Using smart acoustic furniture is an effective way to optimize acoustic properties in a space. Cascando's privacy & acoustic furniture will allow you to fuse great design to the functionality of first-rate sound control. We offer innovative sound absorbing space dividers and a broad selection of acoustic wall panels, desk and ceiling panels. Sustainable solutions that will surely upgrade the working atmosphere of a workspace.

Die Verwendung durchdachter schallabsorbierender Möbel ist eine wirksame Methode zur Optimierung der akustischen Eigenschaften eines Raums. Cascandos Privacy- und Akustikmöbel vereinen schönes Design mit hervorragender Abschirmung und eignen sich daher optimal für die akustikfreundliche Einrichtung des Büros. Wir liefern innovative schallabsorbierende Raumteiler und eine Reihe von schallabsorbierenden Wand-, Tisch- und Deckenpaneelen. Nachhaltige Lösungen, die die Atmosphäre am Arbeitsplatz mit Sicherheit verbessern.

ACOUSTIC REPORTS AND SPECIFICATIONS

Each acoustic product had been tested and certified. You can download the acoustic properties on our website.

- Our acoustic solutions are available with standard or premium absorbing properties
- Standard acoustic properties are equal to Acoustic Class C (DIN-ISO 354:2003)
- Premium acoustic properties are equal to Acoustic Class A (DIN-ISO 354:2003)

Alle akustischen Produkte sind getestet und zertifiziert.

Die Akustik-Rapporte können Sie über unsere Website herunterladen.

- Unsere Akustiklösungen sind in Standard- oder Premium-Absorberqualität erhältlich.
- Die Standard-Absorberqualität entspricht Absorberklasse C (DIN-ISO 354:2003).
- Die Premium-Absorberqualität entspricht Absorberklasse A (DIN-ISO 354:2003).



Scan to download acoustic reports

EXAMPLES OF ACOUSTIC PROPERTIES  
Beispiele von akustischen Eigenschaften

PILLOW GRID PREMIUM PANEL

Class A  
NRC 0,95  
S 0,90

| Hz | 125  | 250  | 500  | 1000 | 2000 | 4000 |
|----|------|------|------|------|------|------|
| s  | 0,24 | 0,62 | 0,94 | 1,06 | 1,08 | 1,07 |

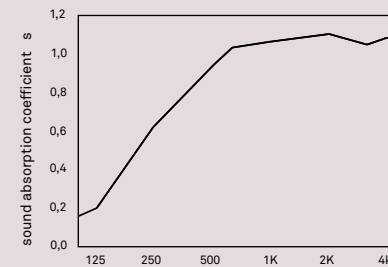

PILLOW GRIS STANDARD PANEL

Class C  
NRC 0,65  
S 0,60

| Hz | 125  | 250  | 500  | 1000 | 2000 | 4000 |
|----|------|------|------|------|------|------|
| s  | 0,11 | 0,32 | 0,66 | 0,76 | 0,89 | 0,95 |

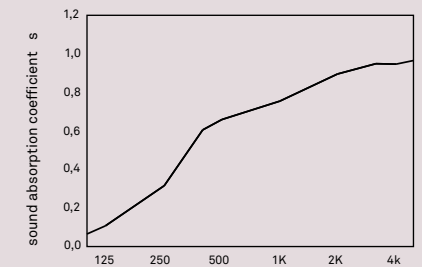

PILLOW SPACE 192X79CM – PREMIUM PANEL

Volume reverberation room: 214 m3  
Signal: broad-band noise  
Bandwidth: 1/3 octave

| Hz      | 125  | 250  | 500  | 1000 | 2000 | 4000 |
|---------|------|------|------|------|------|------|
| 1/3 oct | 1,83 | 2,18 | 2,39 | 3,02 | 3,24 | 3,01 |
| 1/3 oct | 1,38 | 2,21 | 2,58 | 3,08 | 3,16 | 2,91 |
| 1/3 oct | 1,87 | 2,16 | 2,79 | 3,29 | 3,09 | 2,76 |
| 1/1 oct | 1,69 | 2,18 | 2,59 | 3,13 | 3,16 | 2,89 |

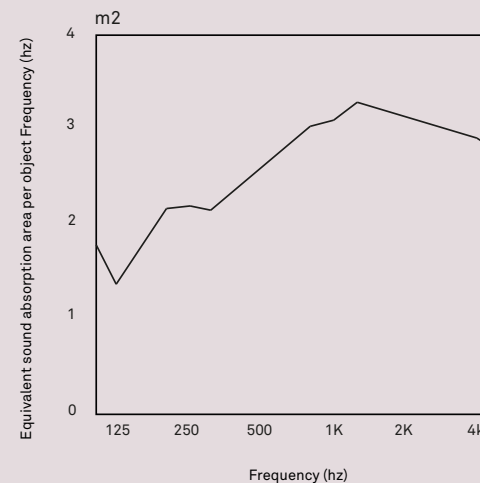

PILLOW SPACE 192X79CM – STANDARD PANEL

Volume reverberation room: 214 m3  
Signal: broad-band noise  
Bandwidth: 1/3 octave

| Hz      | 125  | 250  | 500  | 1000 | 2000 | 4000 |
|---------|------|------|------|------|------|------|
| 1/3 oct | 1,06 | 0,92 | 2,45 | 2,43 | 3,02 | 2,82 |
| 1/3 oct | 1,19 | 1,29 | 2,85 | 2,72 | 3,04 | 2,71 |
| 1/3 oct | 1,24 | 1,27 | 2,12 | 2,93 | 3,05 | 2,49 |
| 1/1 oct | 1,16 | 1,16 | 1,81 | 2,69 | 3,04 | 2,67 |

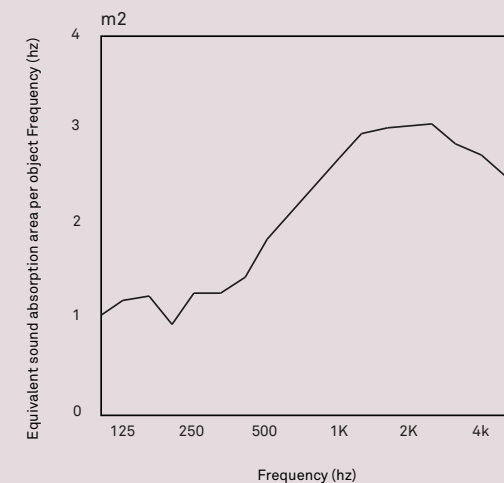

# Incorporate Cascando into your digital plans: CAD data, pCon. planner, OFML data.

## CASCANDO 3D PRODUCT DATA

Cascando 3D product data are available on our website. Simply select your product and configure it. Download the 3D DWG or 3ds Data, the product sheet or add the product to your cart. Do you prefer another 3D file format? Put in a request with our sales department, name the program you use and the preferred file type you would like. All our products are also available as OFML data in pCon planner, pCon box and pCon, facts.

Die 3D Daten der Cascando Produkte sind auf unserer Website verfügbar. Wählen Sie ganz einfach Ihr Produkt und konfigurieren Sie die gewünschte Ausführung. Laden Sie die 3D DWG Daten oder 3ds Daten und das Produktblatt herunter oder fügen Sie das Produkt Ihrem Warenkorb zu. Bevorzugen Sie ein anderes 3-D Format? Senden Sie die Anfrage zu unserer Verkaufsabteilung, nennen Sie das Programm, das Sie benutzen, und den gewünschten Datentyp.

## PCON.PLANNER

pCon.planner is a multifunctional planner (only for Windows) that you can use to create 3D interior designs and presentations in just a few steps. The graphical representations of our products, in both 2D and 3D, have been enhanced using OFML (Office Furniture Modelling Language). OFML data contains additional information such as article numbers, recommended retail prices and product descriptions. You can configure the products easily by selecting options in a step-by-step process. Cascando makes its data available via the software package pCon.update. With pCon.update you download the required software and OFML-enhanced data online when you need them. As the database is managed online, the data is always available quickly, efficiently and inexpensively.

Download the pCon planner ME and sign up for our OFML data via the download page on our website. Make sure you keep your data up-to-date via pCon DataClient.

Der pCon Planner ist ein multifunktionales Planinstrument (nur für Windows geeignet) welches Sie zum Kreieren von 3D Inneneinrichtungen und Präsentationen in wenigen Schritten verwenden können. Die graphische Präsentation unserer Produkte, sowohl in 2D als auch in 3D, wurden durch den Einsatz von OFML (Office Furniture Modelling Language) erweitert. Die OFML Daten beinhalten ergänzende Informationen wie Artikelnummer, empfohlene Retail Preise und Produktbeschreibungen. Indem Sie Schritt für Schritt die verschiedenen Möglichkeiten wählen, konfigurieren Sie Produkte ganz einfach. Die Daten von Cascando sind mit dem Software-Programm pCon update zugänglich. Mit pCon update laden Sie die erforderlichen Programme und die mit OFML ergänzten Daten Online herunter, wann immer Sie diese benötigen. Da die Database Online verwaltet wird, ist diese immer schnell zugänglich, effizient und preiswert.

Laden Sie den pCon Planner ME herunter und schreiben Sie sich über die Download-Umgebung unserer Website ein. Versichern Sie sich über die regelmäßige Aktualisierung Ihrer Daten über pCon DataClient.

Visit our website for:

- 3D CAD data
- OFML data
- pCon planner software
- installation manual



Scan to download  
3D files and software

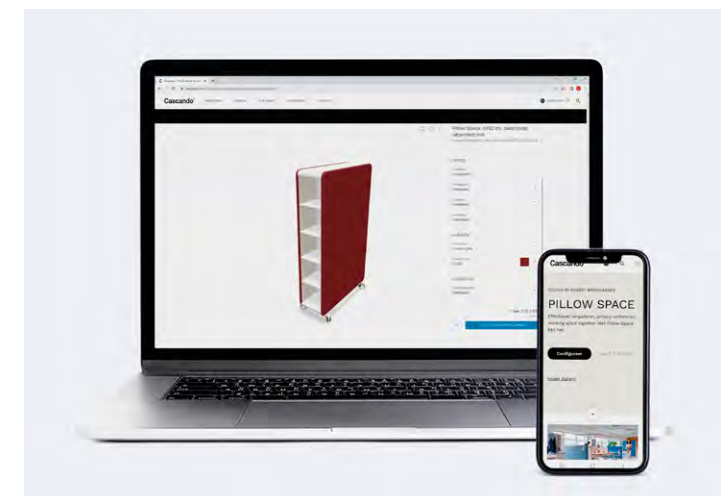

### PCON.BOX

The interactive app pCon.box is highly suitable for dealers. With pCon.box you can easily configure products, give presentations and share product and price information with a customer. pCon.box is available as a mobile app and web-version. Download the software on the download page of the pCon.update site.

Für Händler ist die interaktive App pCon.box sehr gut geeignet. Mit der pCon.box können Sie Produkte ganz einfach konfigurieren, eine Präsentation geben und Produktinformationen sowie Preise mit Kunden teilen. pCon.box ist als Handy-App und als Web-Version verfügbar. Die dazugehörige Software laden Sie über die Download-Umgebung der pCon.update-Site herunter.

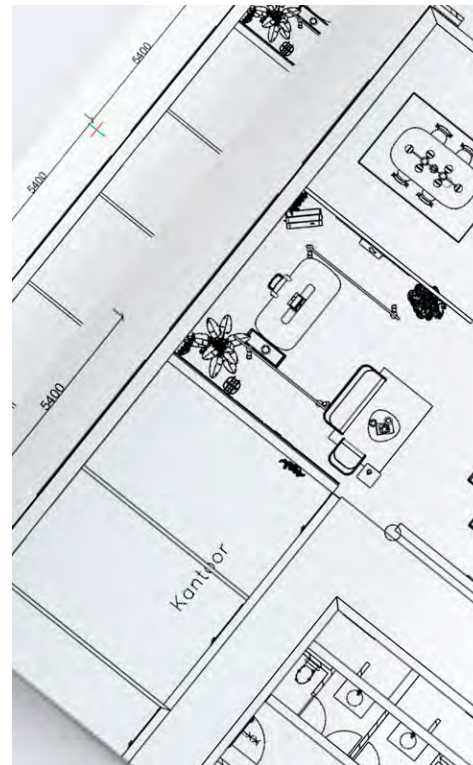

### PCON.FACTS

pCon.facts is also an interactive app suitable for agents and dealers. It's an online price list and configurator in one. Via the built-in augmented reality tool you can now see your designs come to life. Also curious how our products look like in your own space? Download the mobile app on the download page of the pCon.update site.

pCon.facts ist ebenso eine interaktive App, die sowohl für Handelsvertreter als auch Händler geeignet ist. pCon.facts ist eine Online-Preisliste und ein Konfigurator in Einem. Über das eingebaute 'Augmented reality Tool' können Sie Ihre Designs zum Leben bringen. Sind Sie neugierig, wie Produkte in Ihrer eigenen Umgebung zur Wirkung kommen? Laden Sie das Handy-App über die Download-Umgebung der pCon.update-Site herunter.

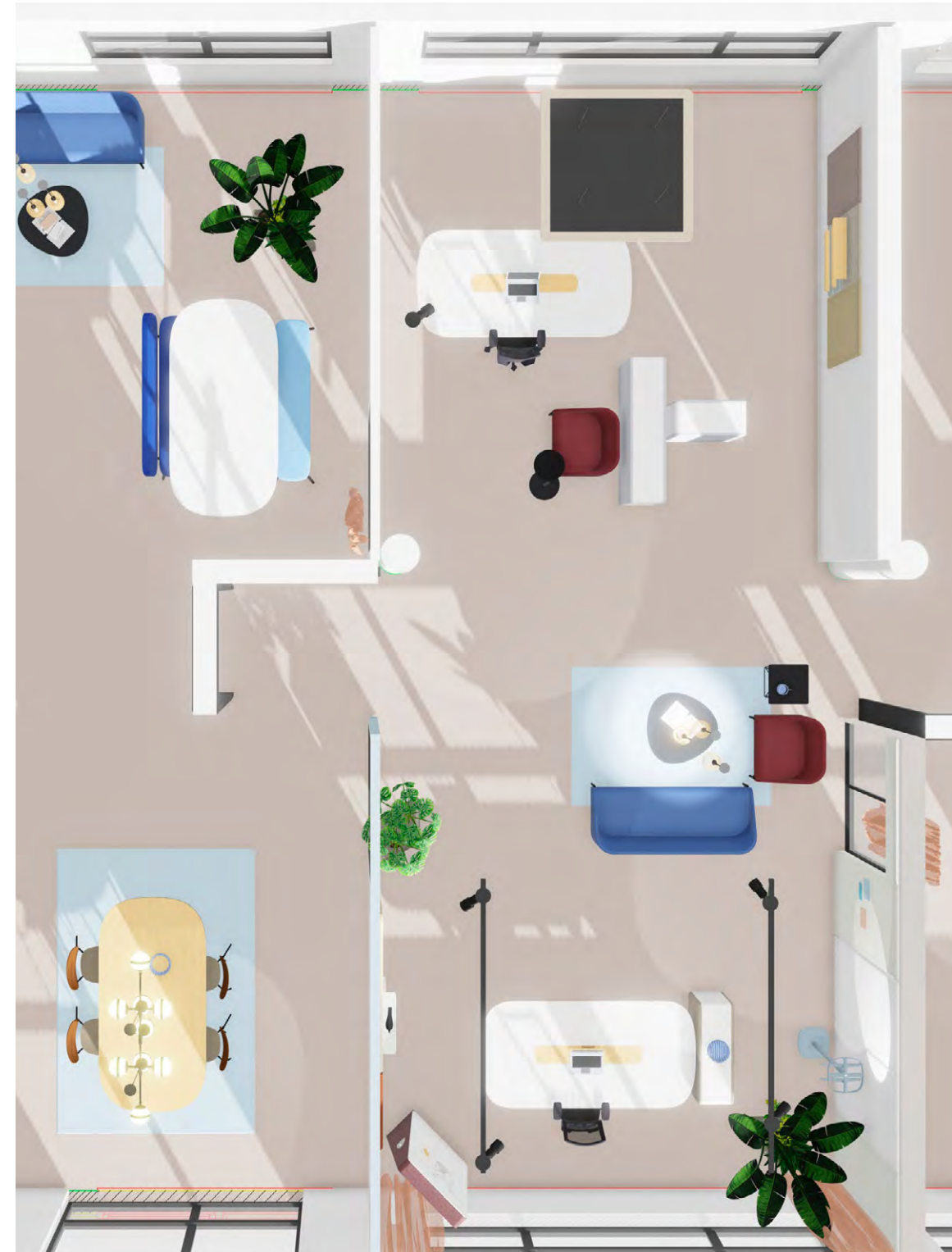



1



2



SELECTED PROJECTS:

1. Porthouse, Antwerp  
Architect: Zaha Hadid Architects  
Photography: Sarah Blee  
Products: Pillow Space acoustic space dividers, Round20 whiteboards, Focus brochure stands

2. Wien Energy Headquarter, Vienna  
Architect: Schenker Salvi Weber  
Photography: David Schreyer  
Products: Rombo planters, Pully poufs

3. Photobox Group / Herbal House, London  
Office Design: Oktra London  
Products: Pillow Space room dividers

4. Coöp, Switzerland  
Interior design: Betz Designmöbel  
Products: Team seating elements

5. Schiphol airport, KLM terminal, Amsterdam  
Photography: Cascando  
Products: Team seating elements

6. Olympic House, Lausanne  
Photography: Olympic.org  
Architect: 3XN & IttenBrechtbühl  
Products: Pole coat stands



3



4



5



6

| CAT. | BRAND | FABRIC |
|------|-------|--------|
|------|-------|--------|

|   |               |                  |
|---|---------------|------------------|
| 0 | CAMIRA        | ERA              |
| 0 | GABRIEL       | CURA             |
| A | CAMIRA        | URBAN            |
| A | CAMIRA        | XTREME           |
| A | GABRIEL       | GO CHECK         |
| B | CAMIRA        | MAIN LINE FLAX   |
| B | CAMIRA        | PATINA           |
| B | GABRIEL       | CHILI            |
| B | GABRIEL       | STEP MELANGE     |
| C | KVADRAT       | REMIX 3          |
| C | KVADRAT       | HERO             |
| C | CAMIRA        | SYNERGY          |
| C | CAMIRA        | BLAZER           |
| C | SERGE FERRARI | STAMSKIN TOP     |
| C | VYVA FABRICS  | SYLVERGUARD      |
| D | KVADRAT       | DIVINA 3         |
| D | KVADRAT       | DIVINA MELANGE 3 |
| D | KVADRAT       | HALLINGDAL 65    |
| D | KVADRAT       | STEELCUT 2       |
| D | KVADRAT       | STEELCUT TRIO 3  |
| D | KVADRAT       | CANVAS 2         |

### FURNITURE FABRICS

- High quality fabrics, suitable for contract furniture
- Furniture fabrics are also suitable for panels up to 120cm wide or wider with a seam
- Other fabrics or customer owned material on request











| CAT. | BRAND | FABRIC |
|------|-------|--------|
|------|-------|--------|

|    |         |               |
|----|---------|---------------|
| P0 | CAMIRA  | CARA          |
| P0 | CAMIRA  | CARLOW        |
| P1 | GABRIEL | SOUL          |
| P1 | GABRIEL | TWIST MELANGE |
| P1 | GABRIEL | TONAL         |
| P1 | GABRIEL | MICA          |
| P1 | CAMIRA  | ERA 170       |
| P2 | CAMIRA  | BLAZER LITE   |
| P2 | CAMIRA  | SYNERGY 170   |
| P2 | KVADRAT | FLOYD SCREEN  |
| P2 | KVADRAT | REMIX SCREEN  |
| P2 | GABRIEL | SOUL MELANGE  |

### PANEL FABRICS

- High quality fabrics, exclusively suitable for panels
- Panel fabrics with matching furniture fabrics: Blazer Lite, Floyd Screen, Synergy 170, Era 170, Remix Screen
- Other fabrics or customer owned material on request

### LEGENDA ICONS

|  |  |  |  |
|--|--|--|--|
|  Acoustic tested |  Fire retardant |  Waterproof |  Ecologic |
|  Stain resistant |  Healthcare     |  Trevira CS |  |
|  Upholstery      |  Panel fabric   |  Recyclable |  |

### COLOURS

Colours can differ from image. For a true colour perspective and up-to-date colour card, please visit the brand's website.

# Fabrics

**CAMIRA  
ERA  
Category D**

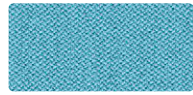

**APPLICATION**  
Task Seating, Soft Seating

**COMPOSITION**  
100% Polyester

**WIDTH**  
140 cm

**WEIGHT**  
320 g/m<sup>2</sup> ±5%

**FLAME RESISTANCE**  
EN 1021 - 1&2  
(cigarette & match)  
BS 7176 Low Hazard  
EN 13501-1  
Adhered Class B, s1, d0  
EN 13501-1 Un-  
Adhered Class C, s1, d0  
BS 7176 Medium Hazard  
with EnviroFlam5

**ABRASION RESISTANCE**  
100,000 Martindale cycles

**FASTNESS TO RUBBING**  
Wet: 4, Dry: 4 (ISO 105 - X12)

**LIGHT FASTNESS**  
5 (ISO 105 - B02)



**GABRIEL  
CURA  
Category 0**



**APPLICATION**  
Contract Seating,  
Soft Seating

**COMPOSITION**  
98% post-consumer  
recycled polyester,  
2% polyester

**WIDTH**  
140 cm

**WEIGHT**  
420 g/m<sup>2</sup>

**FLAME RESISTANCE**  
BS EN 1021 1&2 Cigarette  
and Match  
CA TB 117-2013  
ASTM E 84 Class I

**ABRASION RESISTANCE**  
100,000 Martindale cycles

**FASTNESS TO RUBBING**  
Wet: 4-5, Dry: 4-5  
(ISO 105 - X12)

**LIGHT FASTNESS**  
5-8 (ISO 105 - B02)

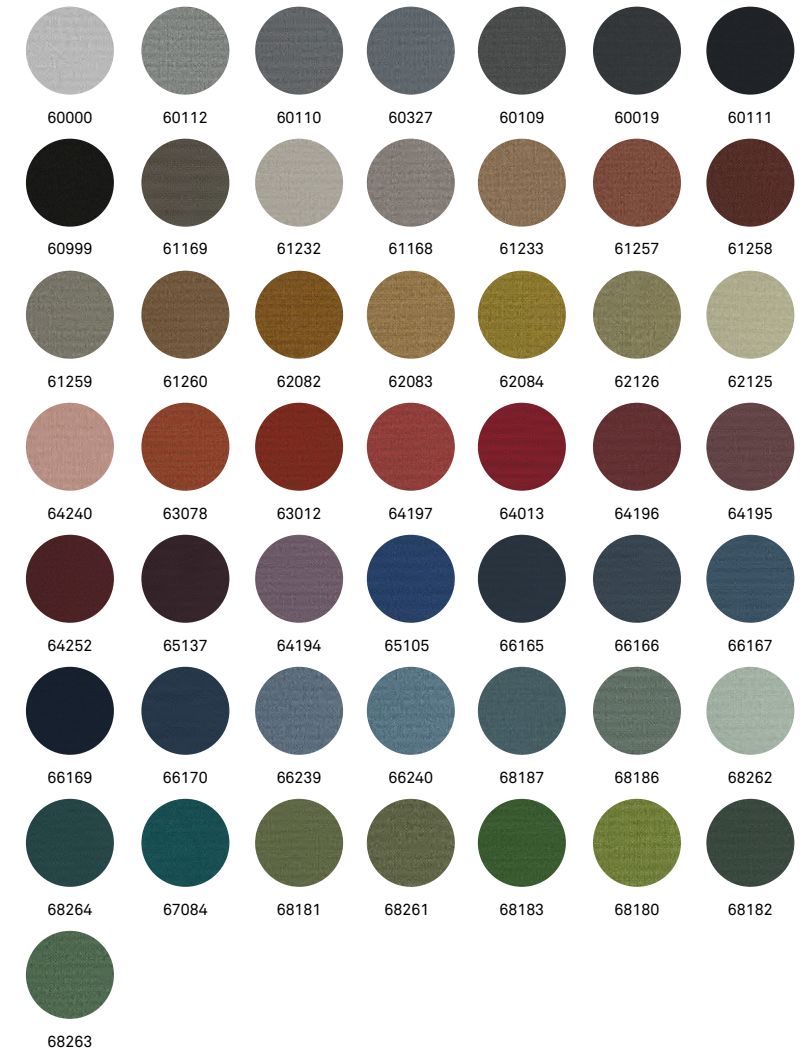

**CAMIRA  
URBAN  
Category A**

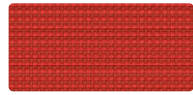

**APPLICATION**  
Task seating

**COMPOSITION**  
100% Recycled Flame  
Retardant Polyester Non  
metallic dyestuffs

**WIDTH**  
140 cm

**WEIGHT**  
340 g/m<sup>2</sup> ±5%  
(480 g/lin.m ±5%)

**FLAME RESISTANCE**  
EN 1021 - 1&2  
(cigarette & match)  
BS 7176 Low Hazard  
BS 5852 Ignition Source 5  
BS 7176 Medium Hazard  
DIN 4102 B1  
ÖNORM A 3800-1 (over  
CMHR 58kg/m<sup>3</sup> Foam)  
UNI 9175 Classe 1 IM

**ABRASION RESISTANCE**  
100,000 Martindale cycles

**FASTNESS TO RUBBING**  
Wet: 4, Dry: 4 (ISO 105 - X12)

**LIGHT FASTNESS**  
6 (ISO 105 - B02)

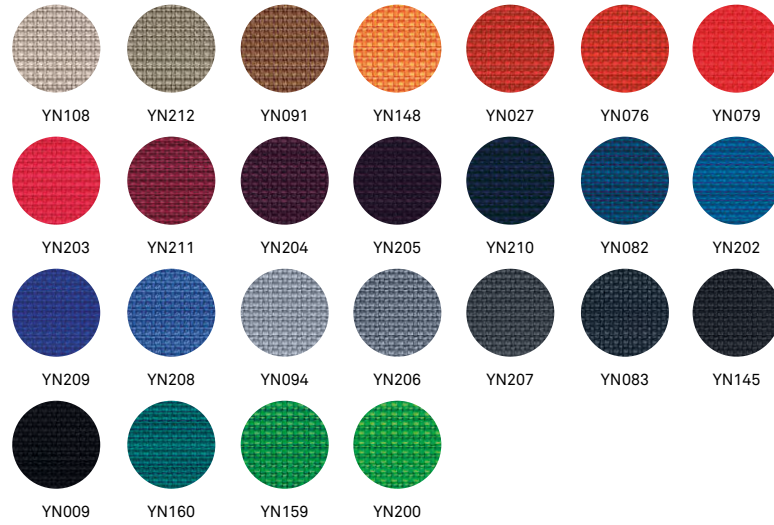

**CAMIRA  
XTREME  
Category A**

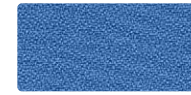

**APPLICATION**  
Task seating

**COMPOSITION**  
100% Recycled Flame  
Retardant Polyester Non  
metallic dyestuffs

**WIDTH**  
140 cm

**WEIGHT**  
310 g/m<sup>2</sup> ±5%  
(435 g/lin.m ±5%)

**FLAME RESISTANCE**  
EN 1021 - 1&2  
(cigarette & match)  
BS 7176 Low Hazard  
BS 5852 Ignition Source 5  
BS 7176 Medium Hazard  
DIN 4102 B1  
NF D 60-013  
ÖNORM B 3825 & A 3800-1  
(over 58 kg/m<sup>3</sup> CMHR foam)  
UNI 9175 Classe 1 IM  
BS 476 Part 7 Class 1

**ABRASION RESISTANCE**  
100,000 Martindale cycles

**FASTNESS TO RUBBING**  
Wet: 4, Dry: 4 (ISO 105 - X12)

**LIGHT FASTNESS**  
6 (ISO 105 - B02)



**FABRICS**



**GABRIEL  
GO CHECK  
Category A**

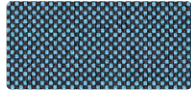

**APPLICATION**  
Contract

**COMPOSITION**  
100% Trevira cs

**WIDTH**  
140 cm

**WEIGHT**  
435 g/lm

**FLAME RESISTANCE**  
BS EN 1021 1&2 Cigarette and Match  
BS EN 1021-1 Cigarette  
BS 5852 Part 1 0,1 Cigarette & match  
BS 5852 Crib 5  
BS 7176 Medium hazard  
DIN 4102 B1  
NFP 92-503/504/505 M1  
ÖNORM B 3825-B1-3800-Q1 UK  
Class Uno UNI 9175 Class 1  
I EMME  
FAR/JAR 25.853 (a) (i) (ii)  
CA TB 117-2013  
DIN EN 13501-1 B-s1,d0

**ABRASION RESISTANCE**  
80,000 Martindale cycles

**FASTNESS TO RUBBING**  
Wet: 4-5, Dry: 4-5  
(ISO 105 - X12)

**LIGHT FASTNESS**  
5 (ISO 105 - B02)

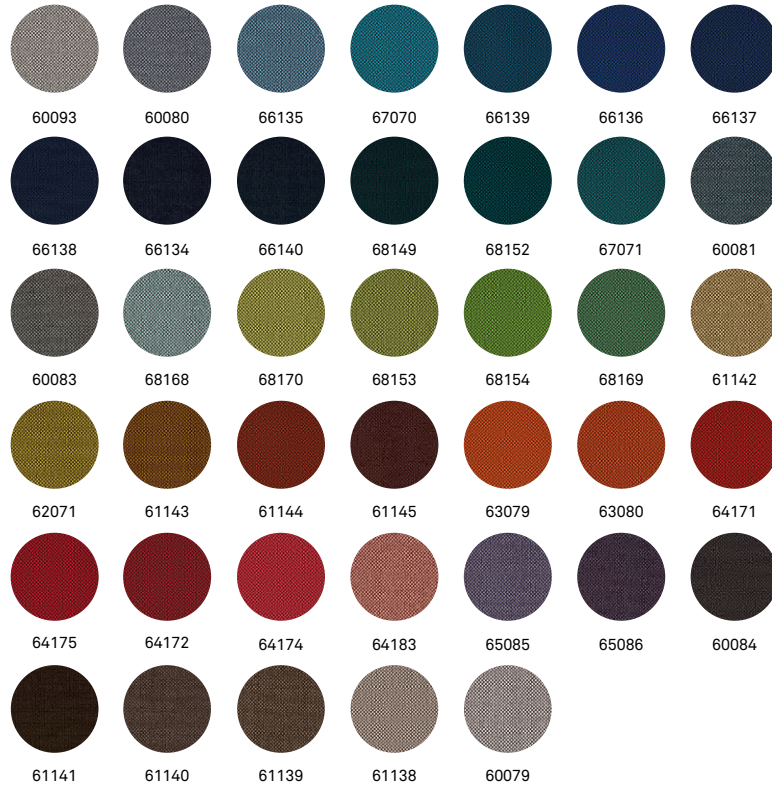

**FABRICS**

**CAMIRA  
MAIN LINE FLAX  
Category B**



**APPLICATION**  
Task seating, Soft seating,  
Curtain

**COMPOSITION**  
75% Virgin Wool, 25% Flax

**WIDTH**  
140 cm

**WEIGHT**  
437 g/m2 ±5%

**FLAME RESISTANCE**  
EN 1021 - 1&2  
(cigarette & match)  
BS 7176 Low Hazard  
BS 5852 Ignition Source 5  
BS 7176 Medium Hazard  
NF D 60-013  
ÖNORM B 3825 & A 3800-1  
(58kg/m3 CMHR Foam)  
UNI 9175 Classe 1 IM  
BS 5867-2: Type B Curtains  
& Drapes  
IMO FTP Code (Part 8)  
The Furniture and Fur-  
nishing (Fire) (Safety)  
Regulations 1988 (Domestic  
Cigarette and Match)

**ABRASION RESISTANCE**  
50,000 Martindale cycles

**FASTNESS TO RUBBING**  
Wet: 3, Dry: 4 (ISO 105 - X12)

**LIGHT FASTNESS**  
5 (ISO 105 - B02)

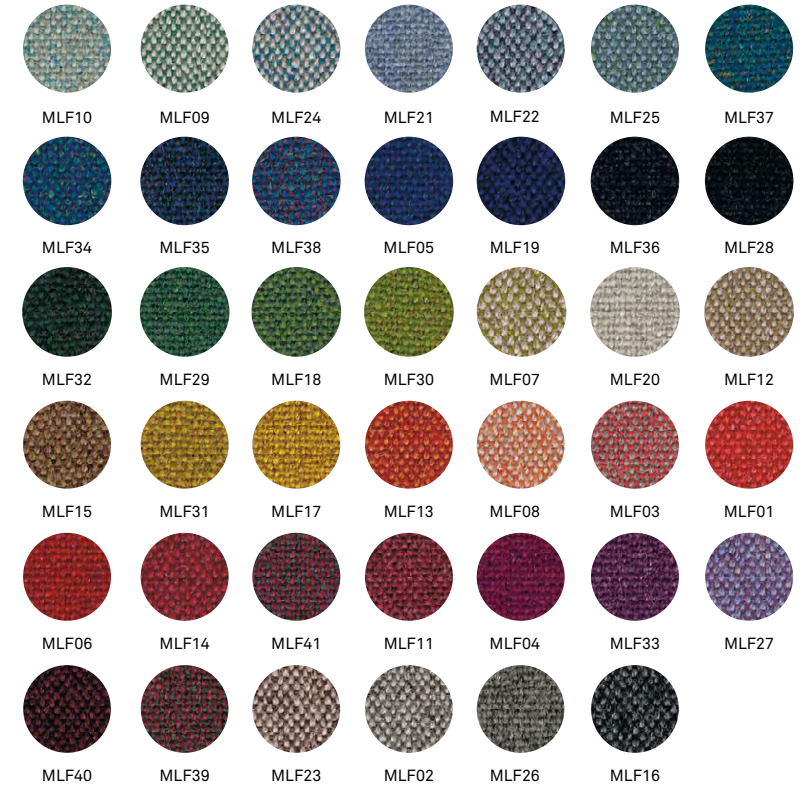

**CAMIRA  
PATINA**  
Category B



**APPLICATION**  
Task Seating, Soft Seating

**COMPOSITION**  
69% Wool, 22% Flax,  
8% Polyamide, 1% Viscose

**WIDTH**  
140 cm

**WEIGHT**  
330 g/m2 ±5%

**FLAME RESISTANCE**  
EN 1021 - 1&2  
(cigarette & match)  
BS 7176 Low Hazard  
BS 5852 Ignition Source 5  
BS 7176 Medium Hazard  
ÖNORM B 3825 & A 3800-1  
(58 kg/m3 CMHR Foam)  
UNI 9175 Classe 1 IM  
BS 5867-2: Type B  
Curtains & Drapes  
The Furniture and  
Furnishing (Fire) (Safety)  
Regulations 1988 (Domestic  
Cigarette and Match)

**ABRASION RESISTANCE**  
100,000 Martindale cycles

**FASTNESS TO RUBBING**  
Wet: 3, Dry: 4 (ISO 105 - X12)

**LIGHT FASTNESS**  
5 (ISO 105 - B02)



**GABRIEL  
CHILI**  
Category B

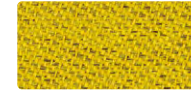

**APPLICATION**  
Task Seating, Soft Seating

**COMPOSITION**  
69% Wool, 22% Flax,  
8% Polyamide, 1% Viscose

**WIDTH**  
140 cm

**WEIGHT**  
330 g/m2 ±5%

**FLAME RESISTANCE**  
CA TB 117-2013  
NFP 92-503/504/505 M1  
DIN 4102 - B1  
Class Uno UNI 9175 Class 1  
I EMME  
BS EN 1021 1&2 Cigarette  
and Match  
BS EN 1021-1 Cigarette  
BS 7176 Medium hazard  
BS 5852 Crib 5  
AM 18 - NFD 60-013-(only  
for fabric)  
DIN EN 13501-1 B-s1,d0

**ABRASION RESISTANCE**  
60,000 Martindale cycles

**FASTNESS TO RUBBING**  
Wet: 4-5, Dry: 4-5  
(ISO 105 - X12)

**LIGHT FASTNESS**  
5-8 (ISO 105 - B02)



**GABRIEL  
STEP MELANGE**  
Category B



APPLICATION  
Contract

COMPOSITION  
100% Trevira cs

WIDTH  
140 cm

WEIGHT  
470 g/lm

FLAME RESISTANCE  
IMO MSC 307(88) Annex 1 part 8  
MED Certificate IMO  
DIN 4102 B1  
NFP 92-503/504/505 M1  
BS EN 1021 1&2 Cigarette and Match  
BS 5852 Part 1 0,1 Cigarette & match  
BS 5852 Crib 5  
ÖNORM B 3825-B1-3800-Q1 UK  
FAR/JAR 25.853 (a) (i) (ii)  
BS 7176 Medium hazard AM 18 - NF D 60-013-(only for fabric)  
CA TB 117-2013  
Class Uno UNI 9175 Class 1  
I EMME  
DIN EN 13501-1 B-s1,d0

ABRASION RESISTANCE  
100,000 Martindale cycles

FASTNESS TO RUBBING  
Wet: 4-5, Dry: 4-5  
(ISO 105 - X12)

LIGHT FASTNESS  
5-7 (ISO 105 - B02)



FABRICS

**KVADRAT  
REMIX 3**  
Category C



APPLICATION  
Upholstery

COMPOSITION  
90% New wool, 10% Nylon

WIDTH  
140 cm

WEIGHT  
415 g/lm

FLAME RESISTANCE  
EN 1021-1/2  
BS 5852 part 1  
Önorm B1/Q1  
NF D 60 013  
UNI 9175 1IM  
AS/NZS 1530.3  
US Cal. Bull. 117-2013  
NFPA 260  
IMO FTP Code 2010: Part 8

ABRASION RESISTANCE  
100,000 Martindale cycles

FASTNESS TO RUBBING  
4 (ISO 105 - X12)

LIGHT FASTNESS  
6 (ISO 105 - B02)



**KVADRAT  
HERO  
Category C**



**APPLICATION**  
Upholstery

**COMPOSITION**  
96% new wool, 4% nylon

**WIDTH**  
140 cm

**WEIGHT**  
560 g/lin. m

**FLAME RESISTANCE**  
AS/NZS 3837 class 2  
BS 5852 Crib 5 with treatment  
BS 5852 part 1  
DIN 4102 B2  
EN 1021-1/2  
IMO FTP Code 2010: Part 8  
NF D 60 013  
NFPA 260  
SN 198 898 5.3 with treatment  
UNI 9175 1IM  
US Cal. Bull. 117-2013

**ABRASION RESISTANCE**  
45,000 Martindale cycles

**FASTNESS TO RUBBING**  
Wet: 4-5, Dry: 4-5  
(ISO 105 - X12)

**LIGHT FASTNESS**  
5-6 (ISO 105 - B02)

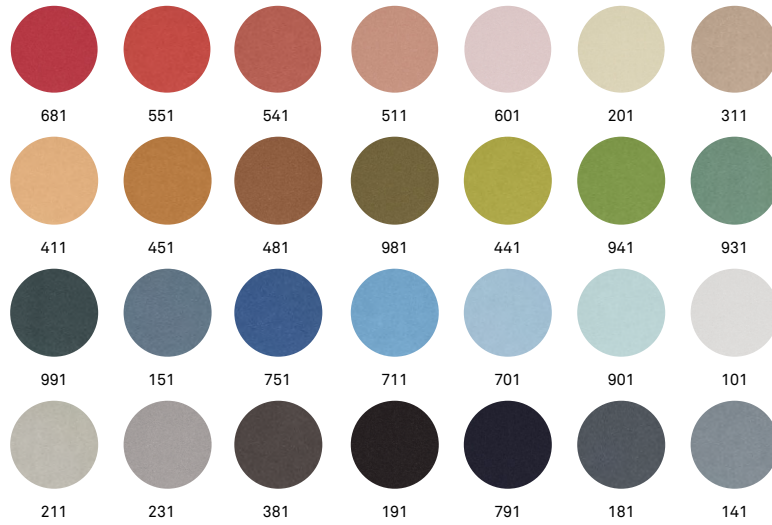

**FABRICS**

**CAMIRA  
SYNERGY  
Category C**



**APPLICATION**  
Task seating and soft seating

**COMPOSITION**  
95% Virgin Wool,  
5% Polyamide

**WIDTH**  
140 cm

**WEIGHT**  
400 g/m<sup>2</sup> ±5%

**FLAME RESISTANCE**  
EN 1021 - 1 (cigarette)  
EN 1021 - 2 (match)  
BS 7176 Low Hazard  
NF D 60-013  
ÖNORM B 3825 & A 3800-1  
(58 kg/m<sup>3</sup> CMHR Foam)  
UNI 9175 Classe 1 IM  
EN 13501 Adhered Class D,  
s1, d0  
EN 13501 Un-adhered  
Class E, s2, d0

**ABRASION RESISTANCE**  
100,000 Martindale cycles

**FASTNESS TO RUBBING**  
Wet: 4, Dry: 4  
(ISO 105 - X12)

**LIGHT FASTNESS**  
5 (ISO 105 - B02)



**CAMIRA  
BLAZER**  
Category C



**APPLICATION**  
Task seating, soft seating,  
curtain

**COMPOSITION**  
100% Virgin Wool  
Non metallic dyestuffs

**WIDTH**  
140 cm

**WEIGHT**  
460 g/m<sup>2</sup> ±5%

**FLAME RESISTANCE**  
EN 1021 - 1 (cigarette)  
EN 1021 - 2 (match)  
BS 7176 Low Hazard  
NF D 60-013  
ÖNORM B 3825 & A 3800-1  
(58kg/m<sup>3</sup> CMHR Foam)  
UNI 9175 Classe 1 IM  
BS 476 Part 7 Class 1  
EN 13501-1 Adhered Class  
D, s1, d0

**ABRASION RESISTANCE**  
50,000 Martindale cycles

**FASTNESS TO RUBBING**  
Wet: 4, Dry: 4 (ISO 105 - X12)

**LIGHT FASTNESS**  
5 (ISO 105 - B02)



**FABRICS**

**SERGE FERRARI  
STAMSKIN TOP**  
Category C



**APPLICATION**  
Task seating

**COMPOSITION**  
Underlayer Polyamid  
- jersey

**WIDTH**  
140 cm

**WEIGHT**  
780 g/m<sup>2</sup>

**FLAME RESISTANCE**  
EN 1021 - 1 (cigarette)  
EN 1021 - 2 (match)  
SN 198898 – VKF/AEAI  
BS 5852 crib 5  
DIN 4102 B1  
UNI 9175 Classe 1 IM

**ABRASION RESISTANCE**  
120,000 Martindale cycles

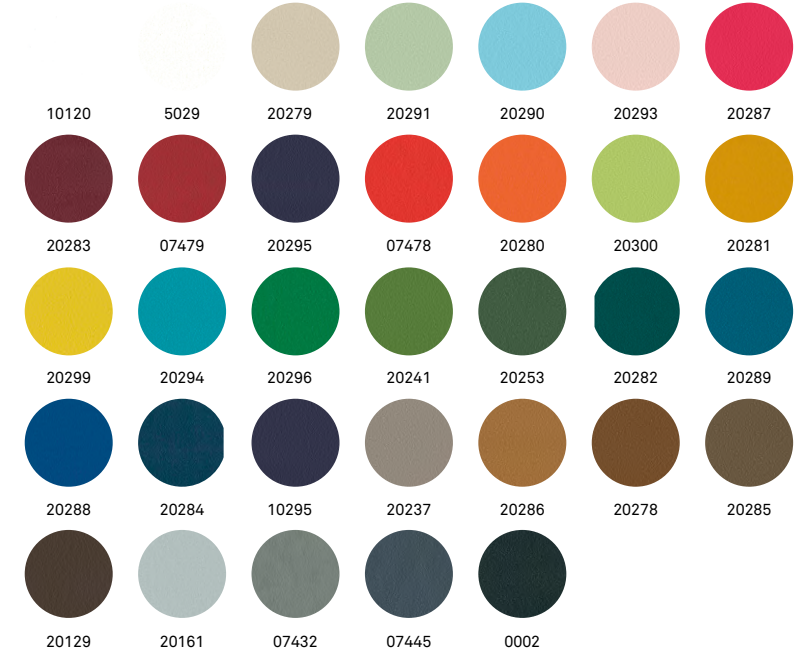

**VYVA FABRICS**  
**SYLVERGUARD**  
 Category C



**APPLICATION**  
 Upholstery

**COMPOSITION**  
 Vinyl/Urethane Topcoat met  
 Hi-Loft<sup>2</sup> backing

**WIDTH**  
 137 cm

**WEIGHT**  
 685 g/m<sup>2</sup>

**FLAME RESISTANCE**  
 EN 1021-1/2

IMO FTP Code 2010

MSC.307: Part 8

BS5852 part 1

UNI 23.727-90 1R/M2

NF P 92-503/M2

DIN 4102 B2

UNI 9175/UNI 9175/Fa1 1IM

ÖNORM B 3825,  
 Gruppe 1-Schwerbrenn-  
 bares Verhalten

ÖNORM A 3800 Teil 1,  
 Qualmbildungsklasse Q1  
 FMVSS 302/FAR 25.853

**ABRASION RESISTANCE**  
 30,000 Martindale cycles



**FABRICS**

**KVADRAT**  
**DIVINA 3**  
 Category D



**APPLICATION**  
 Upholstery

**COMPOSITION**  
 100% new wool

**WIDTH**  
 150 cm

**WEIGHT**  
 840 g/lin.m

**FLAME RESISTANCE**

AS/NZS 1530.3

BS 5852 Crib 5

BS 5852 part 1

DIN 4102 B2

EN 1021-1/2

IMO FTP Code 2010:Part 8

NF D 60 013

**ABRASION RESISTANCE**

45,000 Martindale cycles

**FASTNESS TO RUBBING**

Wet: 4-5, Dry: 4-5  
 (ISO 105 - X12)

**LIGHT FASTNESS**  
 5-6 (ISO 105 - B02)



**KVADRAT**  
**DIVINA MELANGE 3**  
 Category D

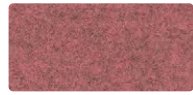

**APPLICATION**  
 Upholstery

**COMPOSITION**  
 100% new wool

**WIDTH**  
 150 cm

**WEIGHT**  
 840 g/lin.m

**FLAME RESISTANCE**  
 AS/NZS 1530.3  
 BS 5852 Crib 5  
 BS 5852 part 1  
 DIN 4102 B2  
 EN 1021-1/2  
 IMO FTP Code 2010:Part 8  
 NF D 60 013  
 NFPA 260  
 Önorm B1/Q1  
 SN 198 898 5.3 with treatment  
 UNI 9175 11M  
 US Cal. Tech. Bull. 117  
 AS.NZS 1530.3

**ABRASION RESISTANCE**  
 45,000 Martindale cycles

**FASTNESS TO RUBBING**  
 Wet: 3-4, Dry: 5  
 (ISO 105 - X12)

**LIGHT FASTNESS**  
 6-7 (ISO 105 - B02)



**KVADRAT**  
**HALLINGDAL 65**  
 Category D



**APPLICATION**  
 Upholstery

**COMPOSITION**  
 70% new wool,  
 30% viscose

**WIDTH**  
 130 cm

**WEIGHT**  
 795 g/lin.m

**FLAME RESISTANCE**  
 EN 1021-1/2  
 BS 5852 Crib 5  
 BS5852 part 1  
 DIN 4102 B2  
 Önorm B1/Q1  
 NF D 60 013  
 NFPA 260  
 SN 198 898 5.3 with treatment  
 UNI 9175 11M  
 US Cal. Bull. 117 – 2013  
 IMO FTP Code 2010: Part 8

**ABRASION RESISTANCE**  
 100,000 Martindale cycles

**FASTNESS TO RUBBING**  
 Wet: 3-4, Dry: 4-5  
 (ISO 105 - X12)

**LIGHT FASTNESS**  
 7 (ISO 105 - B02)



**KVADRAT  
STEELCUT 2  
Category D**



**APPLICATION**

Upholstery

**COMPOSITION**

90% wool, 10% nylon

**WIDTH**

150 cm

**WEIGHT**

Approx. 825 g/lin.m

Flame resistance

EN 1021-1/2

BS 5852 part 1

DIN 4102 B2

Önorm B1/Q1

NF D 60 013

UNI 9175 11M

US Cal. Tech. Bull. 117 NFPA

260

AS/NZS 3837

IMO FTP Code 2010: Part 8

**ABRASION RESISTANCE**

80,000 Martindale cycles

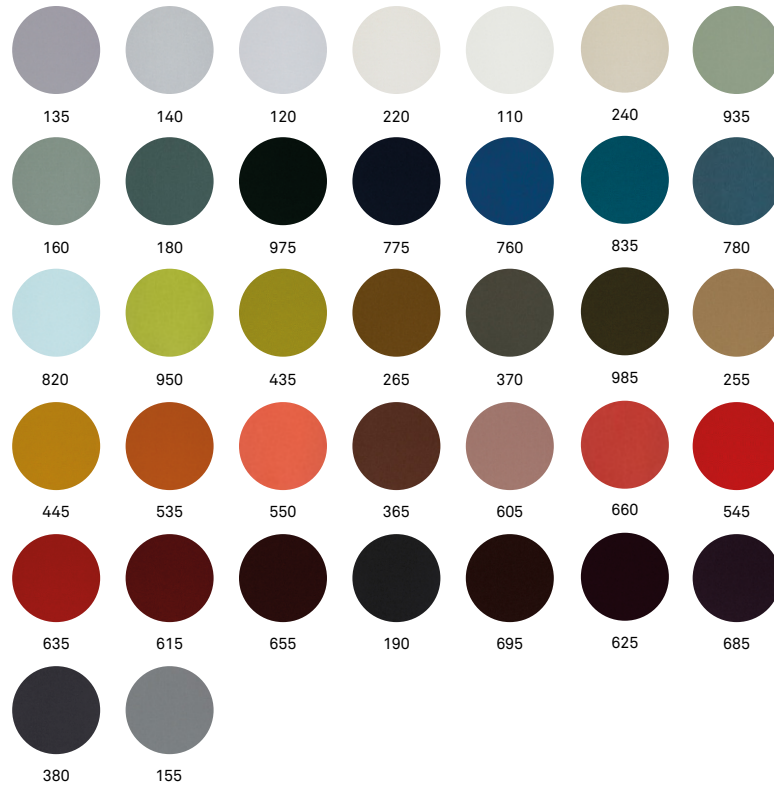

**FABRICS**

**KVADRAT  
STEELCUT TRIO 3  
Category D**



**APPLICATION**

Upholstery

**COMPOSITION**

90% wool, 10% nylon

**WIDTH**

140 cm

**WEIGHT**

Approx. 770 g/lin.m

**FLAME RESISTANCE**

EN 1021-1/2

BS 5852 part 1

DIN 4102 B2

Önorm B1/Q1

NF D 60 013

UNI 9175 11M

US Cal. Bull. 117, – 2013

NFPA 260

AS/NZS 3837

IMO FTP Code 2010: Part 8

**ABRASION RESISTANCE**

100,000 Martindale cycles





**KVADRAT  
CANVAS 2  
Category D**



**APPLICATION**  
upholstery

**COMPOSITION**  
90% new wool worsted,  
10% nylon

**WIDTH**  
140 cm

**WEIGHT**  
480 g/lin. m

**FLAME RESISTANCE**  
AS/NZS 1530.3  
BS 5852 crib 5 with  
treatment  
BS 5852 ignition source 3  
BS 5852 part 1  
IMO FTP Code 2010 Part 8  
NF D 60 013  
NFPA 260  
SN 198 898 5.3 with  
treatment  
UNI 9175 1IM  
US Cal. Bull. 117-2013  
EN 1021-1/2  
ÖNORM B1/Q1

**FASTNESS TO RUBBING**  
100,000 Martindale

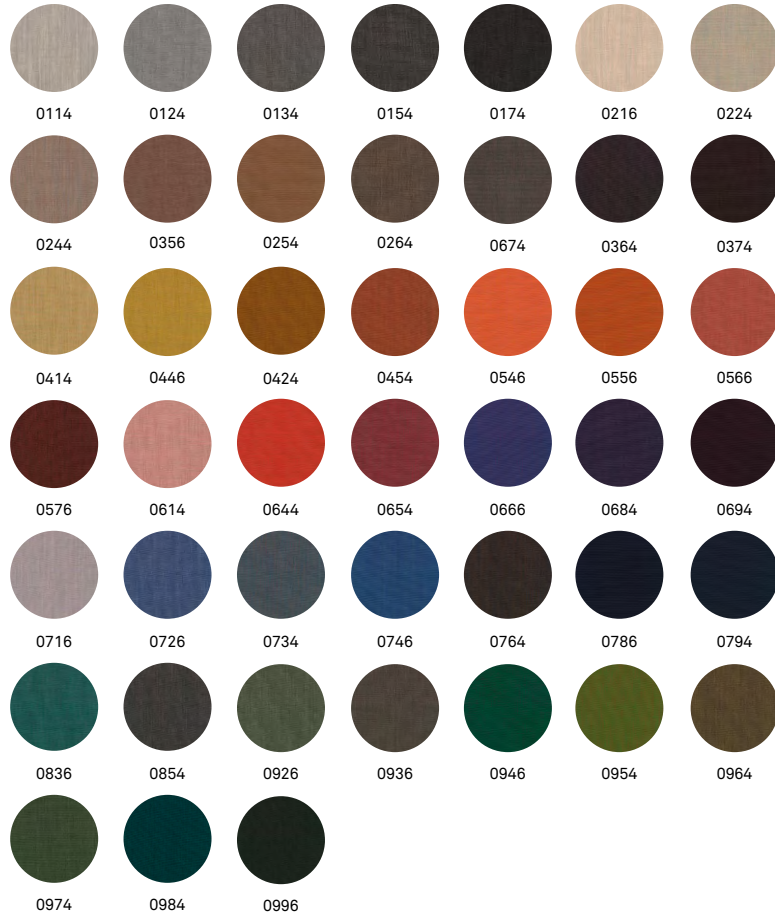

**FABRICS**

**CAMIRA  
CARA  
Category P0**



**APPLICATION**  
Panel

**COMPOSITION**  
100% Polypropylene

**WIDTH**  
170 cm minimum

**WEIGHT**  
220 g/m<sup>2</sup> ±5%

**FLAME RESISTANCE**  
EN 1021-1 (cigarette)  
BS 476 Part 7  
Class 1 (Adhered)  
EN 13501-1  
Adhered Class B, s2, d0

**FASTNESS TO RUBBING**  
Wet: 4, Dry: 4 (ISO 105 - X12)

**LIGHT FASTNESS**  
6 (ISO 105 - B02)

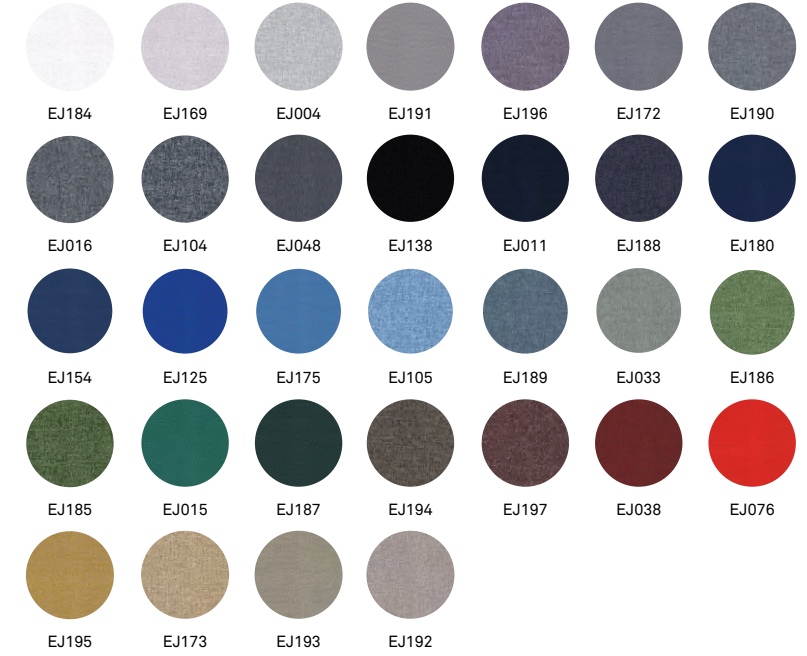

**CAMIRA  
CARLOW**  
Category P0



APPLICATION  
Panel

COMPOSITION  
100% Polypropylene

WIDTH  
170 cm minimum

WEIGHT  
214 g/m<sup>2</sup> ±5%

FLAME RESISTANCE  
EN 1021-1 (cigarette)  
EN 13501-1 Adhered Class  
B, s1, d0  
EN 13501-1 Un-adhered  
Class C, s1, d0

FASTNESS TO RUBBING  
Wet: 4, Dry: 4 (ISO 105 - X12)

LIGHT FASTNESS  
6 (ISO 105 - B02)

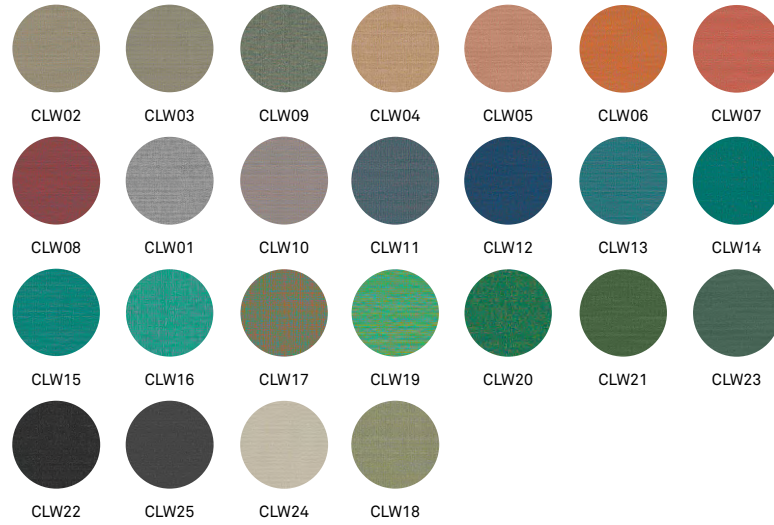

FABRICS

**GABRIEL  
SOUL**  
Category P1



APPLICATION  
Panel

COMPOSITION  
100% wool

WIDTH  
170 cm

WEIGHT  
330 g/m<sup>2</sup>

FLAME RESISTANCE  
BS 476 Part 7 class I  
ÖNORM A3800-B1-  
B3825-Q1 UK  
BS 5852 Crib 5 (flame  
retardant)

FASTNESS TO RUBBING  
Wet: 4-5, Dry: 4-5  
(ISO 105 - X12)

LIGHT FASTNESS  
5-7 (ISO 105 - B02)



**GABRIEL  
TWIST MELANGE**  
Category P1

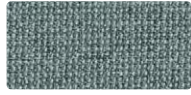

**APPLICATION**  
Panel

**COMPOSITION**  
100% Trevira cs

**WIDTH**  
170cm

**WEIGHT**  
370 g/lm

**FLAME RESISTANCE**  
ASTM E 84  
DIN 4102 B1  
NFP 92-503/504/505 M1  
BS 476 Part 7, class 1  
Class Uno UNI 9175 Class 1  
I EMME  
Class Uno UNI 9177 - Class  
1 I EMME  
Class Uno UNI 9174 - UNI  
8457  
DIN EN 13501-1 B-s1,d0

**FASTNESS TO RUBBING**  
Wet: 4-5, Dry: 4-5  
(ISO 105 - X12)

**LIGHT FASTNESS**  
5-7 (ISO 105 - B02)

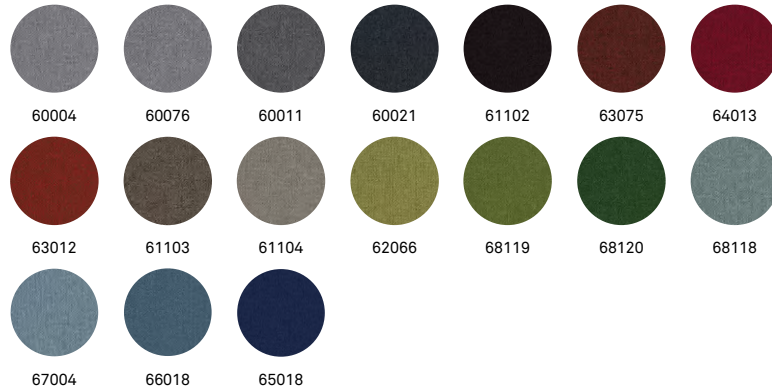

**GABRIEL  
TONAL**  
Category P1

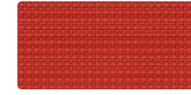

**APPLICATION**  
Cross functional contract

**COMPOSITION**  
99% post-consumer  
recycled polyester,  
1% polyester

**WIDTH**  
170 cm

**WEIGHT**  
385 g/lm

**FLAME RESISTANCE**  
CA TB 117-2013  
ASTM E 84 Class I  
BS EN 1021 1&2 Cigarette  
and Match  
BS EN 1021-1 Cigarette  
BS 476 Part 7 class I

**ABRASION RESISTANCE**  
100,000 Martindale cycles

**FASTNESS TO RUBBING**  
Wet: 4-5, Dry: 4-5  
(ISO 105 - X12)

**LIGHT FASTNESS**  
6-8 (ISO 105 - B02)

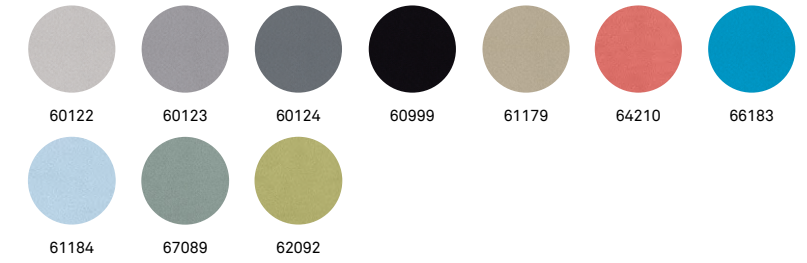

**GABRIEL  
MICA**  
Category P1



**APPLICATION**  
Cross functional contract

**COMPOSITION**  
97% post-consumer recycled polyester,  
3% polyester

**WIDTH**  
2496 light/2497 dark:  
140 cm  
2500 light/2501 dark:  
170 cm

**WEIGHT**  
2496 light/2497 dark:  
305 g/lm.  
2500 light/2501 dark:  
370 g/lm.

**FLAME RESISTANCE**  
CA TB 117-2013  
ASTM E 84 Class I  
BS EN 1021-1 Cigarette  
BS EN 1021-2 Match  
BS 476 Part 7 class I

**ABRASION RESISTANCE**  
60,000 Martindale cycles

**FASTNESS TO RUBBING**  
Wet: 4-5, Dry: 4-5  
(ISO 105 - X12)

**LIGHT FASTNESS**  
5-8 (ISO 105 - B02)

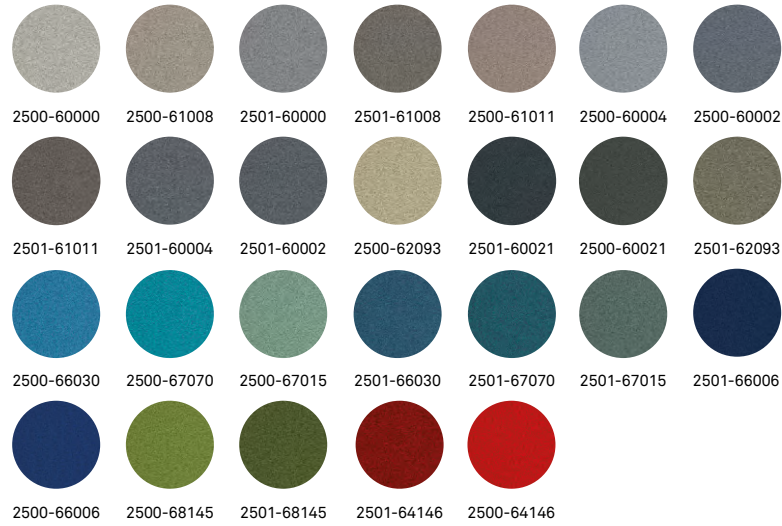

**FABRICS**

**CAMIRA  
ERA 170**  
Category P1

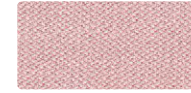

**APPLICATION**  
Soft Seating and Panel

**COMPOSITION**  
100% Polyester

**WIDTH**  
170 cm minimum

**WEIGHT**  
320 g/m2 ±5%

**FLAME RESISTANCE**  
EN 1021 - 1&2 (cigarette &  
match)  
BS 7176 Low Hazard  
EN 13501-1 Adhered Class  
B, s1, d0  
EN 13501-1 Un-adhered  
Class C, s1, d0

**ABRASION RESISTANCE**  
100,000 Martindale cycles

**FASTNESS TO RUBBING**  
Wet: 4, Dry: 4 (ISO 105 - X12)

**LIGHT FASTNESS**  
5 (ISO 105 - B02)

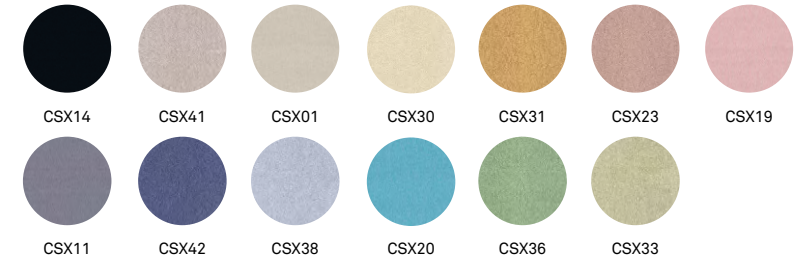

**CAMIRA  
BLAZER LITE  
Category P2**



**APPLICATION**  
Panel

**COMPOSITION**  
100% Virgin Wool

**WIDTH**  
170 cm minimum

**WEIGHT**  
355 g/m<sup>2</sup> ±5%

**FLAME RESISTANCE**  
BS 476 Part 7 Class 1  
BS 476 Part 6 Class 0  
EN 13501-1 Adhered Class  
C, s1, d0

**FASTNESS TO RUBBING**  
Wet: 4, Dry: 4 (ISO 105 - X12)

**LIGHT FASTNESS**  
5 (ISO 105 - B02)

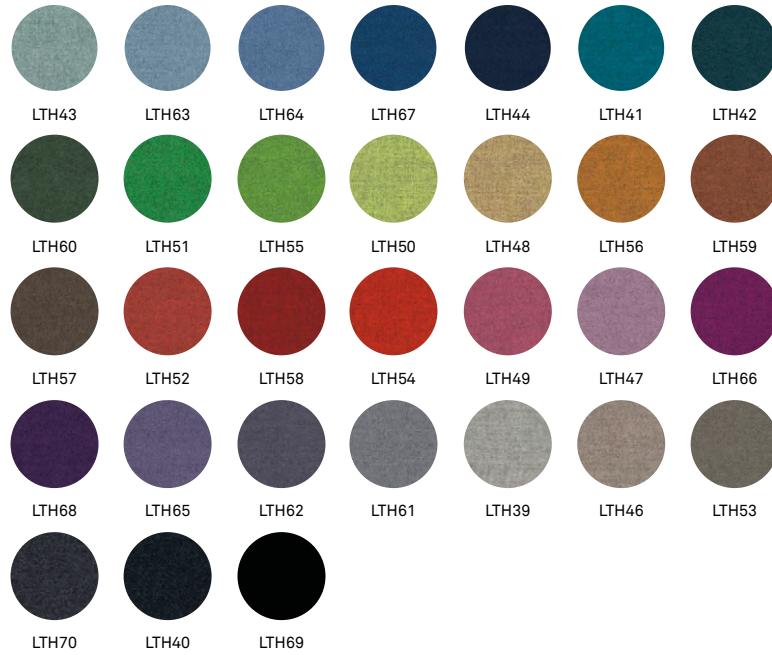

**FABRICS**

**CAMIRA  
SYNERGY 170  
Category P2**



**APPLICATION**  
Soft seating, Panel

**COMPOSITION**  
95% Virgin Wool,  
5% Polyamide

**WIDTH**  
170 cm minimum

**WEIGHT**  
400 g/m<sup>2</sup> ±5%

**FLAME RESISTANCE**  
EN 1021 - 1&2 (cigarette &  
match)  
BS 7176 Low Hazard  
ÖNORM B 3825 & A 3800-1  
(over 58 kg/m<sup>3</sup> CMHR foam)  
UNI 9175 Classe 1 IM  
EN 13501-1 Adhered Class  
D, s1, d0  
EN 13501-1 Un-adhered  
Class E, s2, d0

**ABRASION RESISTANCE**  
100,000 Martindale cycles

**FASTNESS TO RUBBING**  
Wet: 4, Dry: 4 (ISO 105 - X12)

**LIGHT FASTNESS**  
5 (ISO 105 - B02)

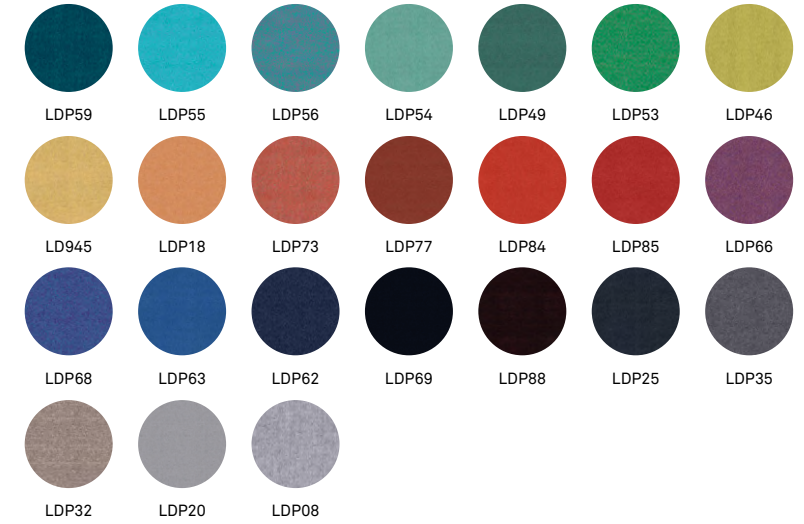

**KVADRAT  
FLOYD SCREEN**  
Category P2



**APPLICATION**

Panel

**COMPOSITION**

45% new wool,  
50% polyester,  
5% nylon

**WIDTH**

App. 170 cm

**WEIGHT**

App. 370 g/lin.m

**FLAME RESISTANCE**

BS 476 part 7 + 6 when  
glued

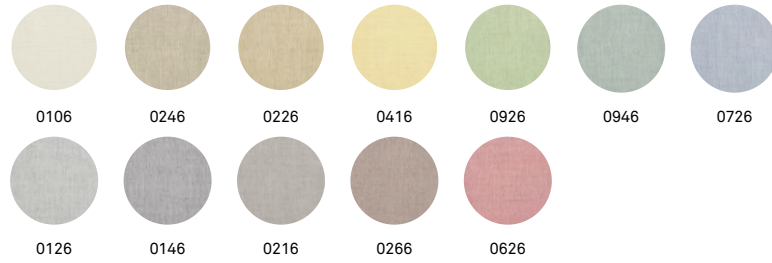

**FABRICS**

**KVADRAT  
REMIX SCREEN**  
Category P2

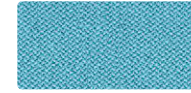

**APPLICATION**

Panel

**COMPOSITION**

90% new wool worsted,  
10% nylon

**WIDTH**

170 cm

**WEIGHT**

450 g/lin. m

**FLAME RESISTANCE**

ASTM E84 Class A Adhered  
AS/NZS 3837 class 2  
AS/NZS 1530.3  
DIN 4102 B1 adhered  
BS 476 part 7 + 6 adhered

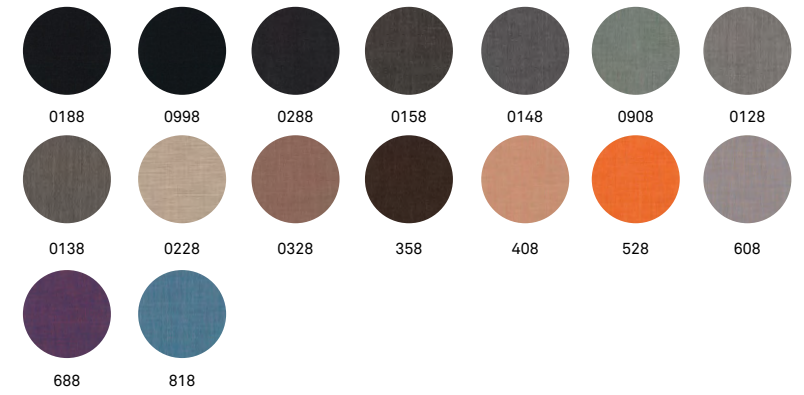

**GABRIEL**  
**SOUL MELANGE**  
 Category P2



**APPLICATION**

Panel

**COMPOSITION**

84% wool, 16% polyester

**WIDTH**

170 cm

**WEIGHT**

330 g/lm

**FLAME RESISTANCE**

BS 476 Part 7 class I

BS EN 1021 1&2 Cigarette  
 and Match

Will also pass other flam-  
 mability standards. Flame  
 retardant performance is  
 dependent upon the foam  
 used. Contains no flame  
 retardant chemicals.

**FASTNESS TO RUBBING**

Wet: 4-5, Dry: 4-5

(ISO 105 - X12)

**LIGHT FASTNESS**

5-7 ISO 105-B02



# The Collection

## Space dividers

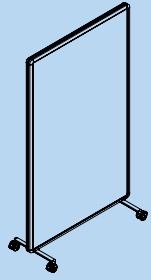

Patio | 28

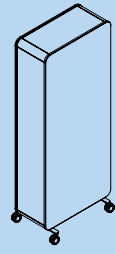

Pillow Space | 52

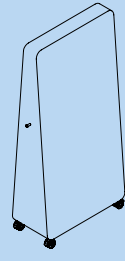

Trunk | 62

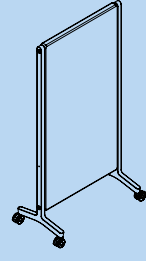

Round20 Oak | 68

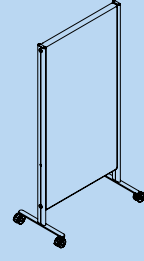

Round20 Alu | 76

## Acoustic panels

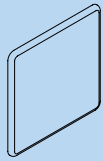

Pillow Wall | 82

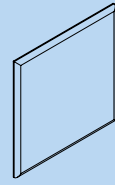

Pillow Grid | 88

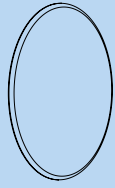

Pillow Round | 98

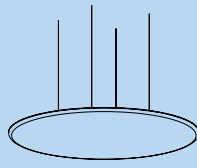

Pillow Free | 100

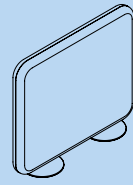

Pillow Desk | 102

## Seating

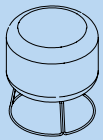

Paddy Pouf | 106

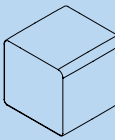

Team Pouf | 108

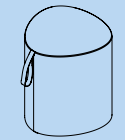

Pully Pouf TR | 110

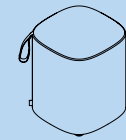

Pully Pouf SQ | 110

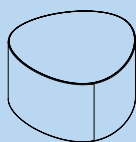

Pully Island TR | 114

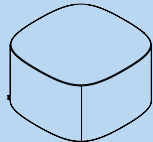

Pully Island SQ | 114

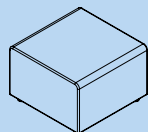

Team BSM | 138

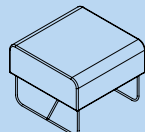

Team LSM | 142

## Seating

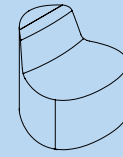

Pully Seat TR | 128

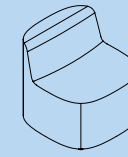

Pully Seat SQ | 128

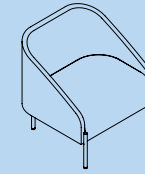

Bond | 130

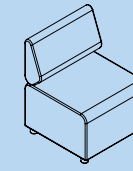

Team BSM | 138

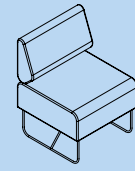

Team LSM | 142

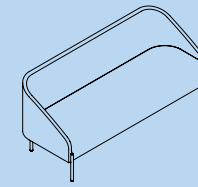

Bond | 130

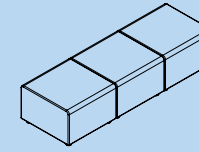

Team BSM | 138

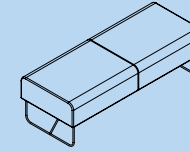

Team LSM | 142

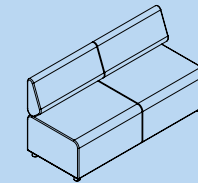

Team BSM | 138

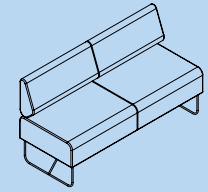

Team LSM | 142

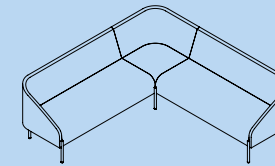

Bond | 130

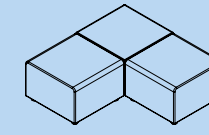

Team BSM | 138

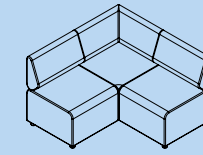

Team BSM | 138



Pully barstool TR | 116

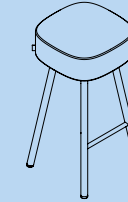

Pully barstool SQ | 116

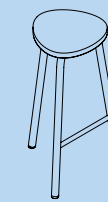

Pully barstool TR | 120

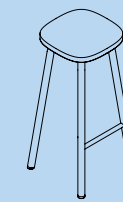

Pully barstool SQ | 120

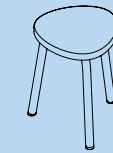

Pully stool TR | 120

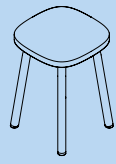

Pully stool SQ | 122

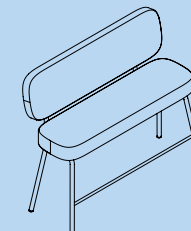

Pully Bench | 124

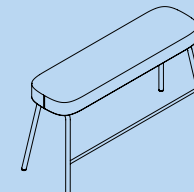

Pully Bench | 124

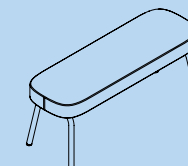

Pully Bench | 126



Tables

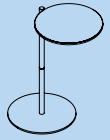

Bond laptop | 150

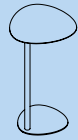

Pully Side TR | 152

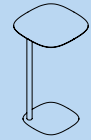

Pully Side SQ | 152

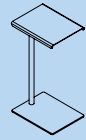

Team laptop | 154



Paddy | 156

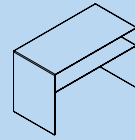

U2XL | 158



Pully Hub TR | 160

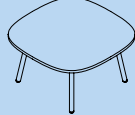

Pully Hub SQ | 160

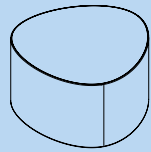

Pully Islands TR | 176

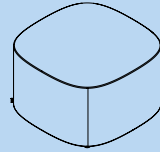

Pully Islands SQ | 176



Pully Hub TR | 160

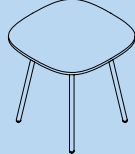

Pully Hub SQ | 160

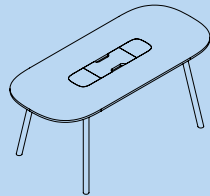

Pully Meet | 164

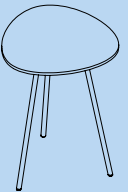

Pully Hub TR | 160

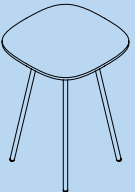

Pully Hub SQ | 160

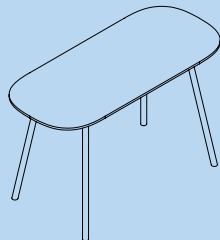

Pully Meet | 164

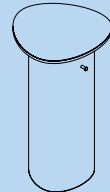

Pully Pillar TR | 172

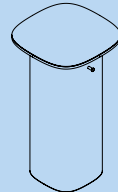

Pully Pillar SQ | 172

Wardrobe



Flower | 180



Flower Plus | 180



Flow | 186

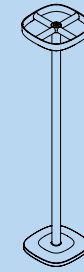

Plus | 188

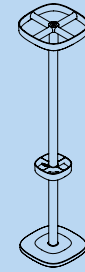

Plus + | 188



Standalone | 192

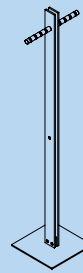

Standfree | 194

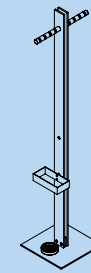

Standfree-P | 194



Basket | 198



Tree | 200



Bend | 202



Pole | 204

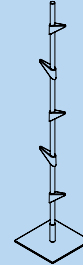

Bamboo I | 206

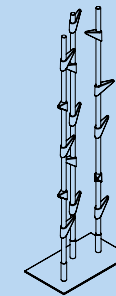

Bamboo III | 206



Kendo | 210

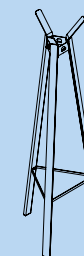

Fuse | 212

Wardrobe

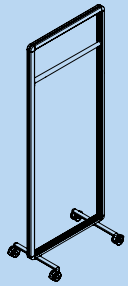

Patio | 214

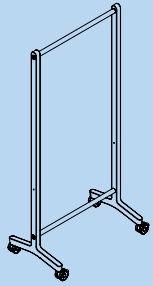

Round20 Oak S | 216

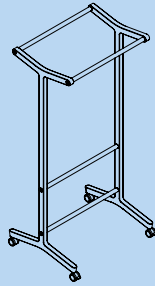

Round20 Oak D | 218

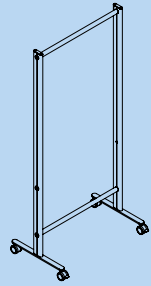

Round20 Alu | 220

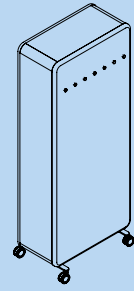

Pillow Space | 232

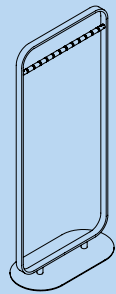

Focus | 222

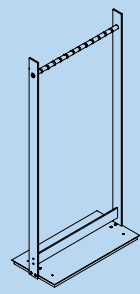

Standtogether | 226

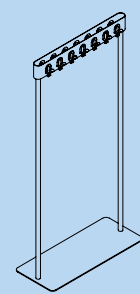

Flow Large | 228

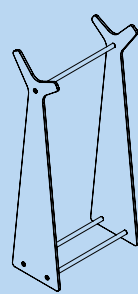

Forest | 230

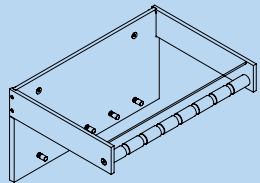

Hangan 7-12 | 238

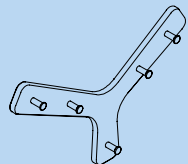

Branch | 243

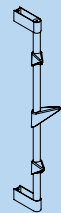

Bamboo | 244

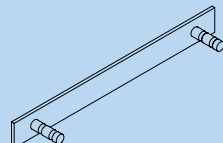

Hangan Double | 234



Bend | 242

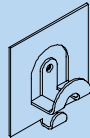

Flow | 240

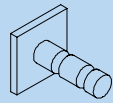

Hangan | 235

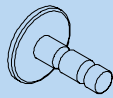

Clickon | 237

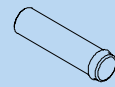

Stick | 236

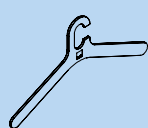

Pole | 246

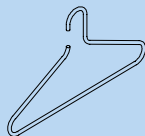

Lean on | 248

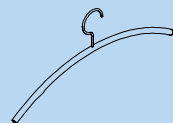

Chrome | 249

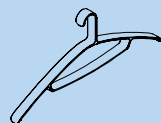

Plus | 250

Display and storage

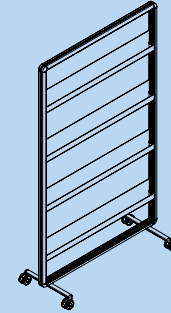

Patio | 254

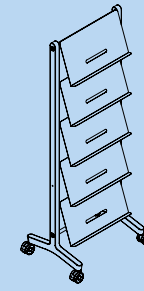

Round20 Oak | 262

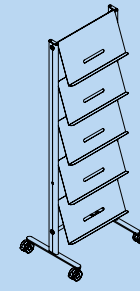

Round20 Alu | 264

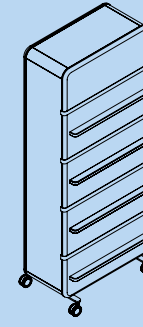

Pillow Space | 274



Focus | 266



Flexible Single | 268



Flexible Double | 268

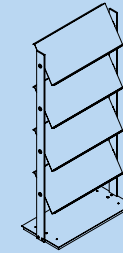

Flexible Large | 268

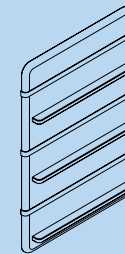

Pillow Wall | 82

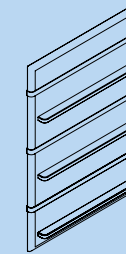

Pillow Grid | 88



Round20 Wall | 276



Round20 Wall | 276

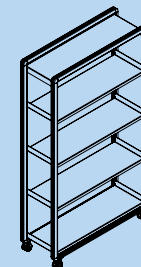

Patio | 254

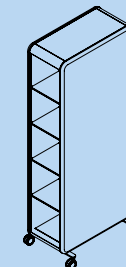

Pillow Space | 274

Video meeting furniture

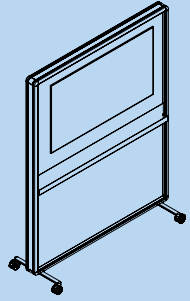

Patio | 280

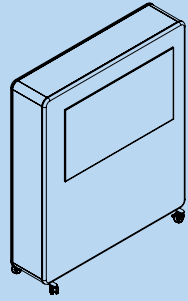

Pillow Space | 282

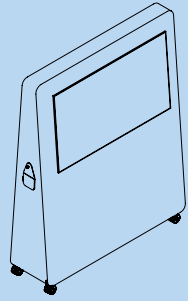

Trunk | 284

Whiteboards

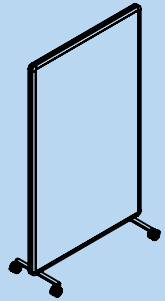

Patio | 288

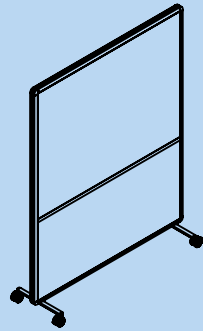

Patio | 288

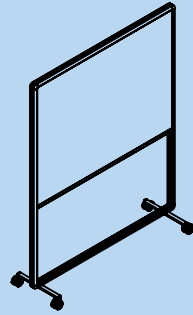

Patio | 288

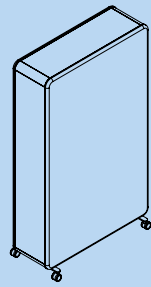

Pillow Space | 292

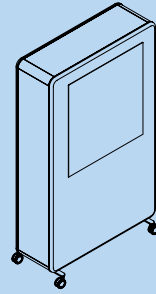

Pillow Space | 292

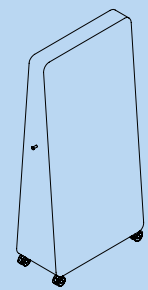

Trunk | 296

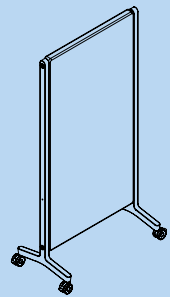

Round20 Oak | 298

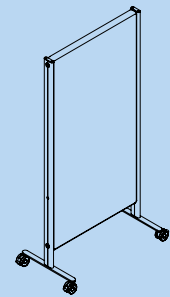

Round20 Alu | 300

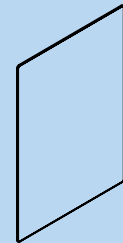

Pillow Grid | 302

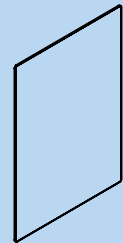

Round20 Wall | 304

Planters

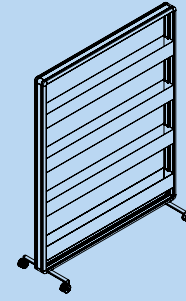

Patio | 308

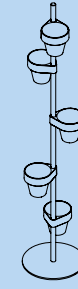

Slide | 310

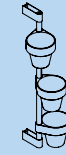

Slide Wall | 310

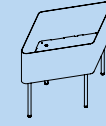

Rombo | 316

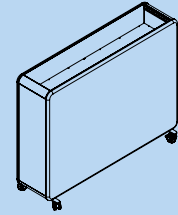

Pillow Space | 318

Umbrella stand

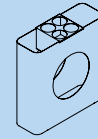

Flow I | 322



Flow II | 324

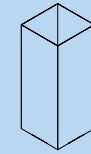

Square | 324



Flower | 326

Paper bins

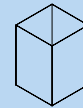

Square | 330

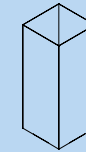

Square | 330

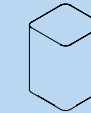

Flow | 334

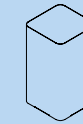

Flow | 334

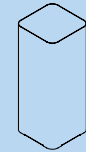

Flow | 334

REGIONAL SALES OFFICESAUSTRIA

Design4Architects  
 Franz Steiner  
 St. Severinstrasse 32/5  
 A-3313 Wallsee  
 T 0043-6649116177  
 E franz.steiner@  
 design4architects.com

BELGIUM

Concep'trade  
 mevr. Herreman / dhr. Vanherck  
 Klein Begijnhof Bogaard 5  
 B-2800 Mechelen  
 T 0032-15330725  
 E info@conceptrade.be

FRANCE

Wagemans Mobilier  
 Daniel Wagemans  
 496 Route des Pinoux  
 F-01570 Manziat  
 T 0033-385301029  
 E info@wagemans.fr

DENMARK

Arnesco Scandinavia  
 Hellerupvej 10 - Baghuset 1 sal  
 DK 2900 Hellerup CPH  
 T 0045-43711938  
 M 0045-40571938  
 E info@arnesco.dk

GERMANY PLZ 0, 1 & 99

Handelsagentur Richter  
 Eberhard Richter  
 Louis-Braille-Strasse 21  
 D-99510 Apolda  
 T 0049-3644517527  
 E agentur.richter@t-online.de

GERMANY PLZ 2 & 3

Idea-Objekt Hannover  
 Uwe Wöhlk  
 Tiestestrasse 36  
 D-30173 Hannover  
 T-0049-5112283334  
 E uwe@idea-objekt.com

GERMANY PLZ 4 & 5

objectiv Raumakustik + Möbel  
 Pieter Niessen  
 Waltherstrasse 49-51  
 D-51069 Koeln  
 T 0049-221 / 16 88 98-0  
 E niessen@objectiv.de

GERMANY PLZ 6

FREIRAUM  
 Michael Günter Frei  
 Bahnhofstrasse 31  
 D-61130 Nidderau - Heldenbergen  
 T 0049-61879097316  
 E michaelfrei@freiraum-mf.de

GERMANY PLZ 7, 8 & 9

Idea-Objekt München  
 Volker Breuckmann  
 Erminoldstrasse 88  
 D-81735 München  
 T 0049-8968072862  
 E welcome@idea-objekt.com

LUXEMBOURG

Concep'trade  
 mevr. Herreman / dhr. Vanherck  
 Klein Begijnhof Bogaard 5  
 B-2800 Mechelen  
 T 0032-15330725  
 E info@conceptrade.be

NORWAY

Cascando Products b.v.  
 Impact 2  
 NL-6921 RZ Duiven  
 T 0031-26 3519603  
 E design@cascando.nl

SPAIN

Absolutdesign - Rubio showroom  
 Paula Espinar  
 C/Volta 38-42  
 08224 Terrassa (Barcelona)  
 T 0034-630789214  
 E info@absolutdesign.es

SWEDEN

Cascando Products b.v.  
 Impact 2  
 NL-6921 RZ Duiven  
 T 0031-26 3519603  
 E design@cascando.nl

SWITZERLAND

Agentur Geiger GmbH  
 Marc Geiger  
 Werftstrasse 2  
 CH-6005 Luzern  
 T 0041-448881100  
 E info@agentur-geiger.ch

UK

Crest London  
 Unit 211  
 Westminster Industrial Estate  
 13 Westfield Street  
 London  
 SE18 5PH  
 T 044-2088544229  
 E hello@crest.london

CASCANDO PRODUCTS B.V.

Impact 2  
 NL-6921 RZ Duiven  
 The Netherlands  
 T +31(0)26 35 19 603  
 I www.cascando.com  
 E design@cascando.nl

## MEET US

CASCANDO SHOWROOMS

Design Post Köln  
 Deutz-Mülheimer-Strasse 22a  
 50679 Köln, Germany  
 T 0049-221 69 06 50  
 I www.designpostkoeln.de  
 E info@designpostkoeln.de

Design Post Amsterdam  
 Cruquiusweg 111 M  
 1019 AG Amsterdam  
 T 0031 20 599 6420  
 I www.designpostamsterdam.nl  
 E info@designpostamsterdam.nl



COLOPHON

Identity: Floor Knaapen  
Photography: Floor Knaapen, Paul Lagro  
Styling: Tessa Hemink  
Concept & Art direction: Smel \*creative agency  
Graphic design: Margriet van Sonsbeek  
Portrait photography: Iris Duvekot, Wouter Jansen  
Renders: Jurriaan Borstlap, Joep Swagemakers  
Text: <JNSN> Arold Jansen, Team Cascando

Subject to printer's errors  
[www.cascando.com](http://www.cascando.com)

CASCANDO

## TOP LAYERS

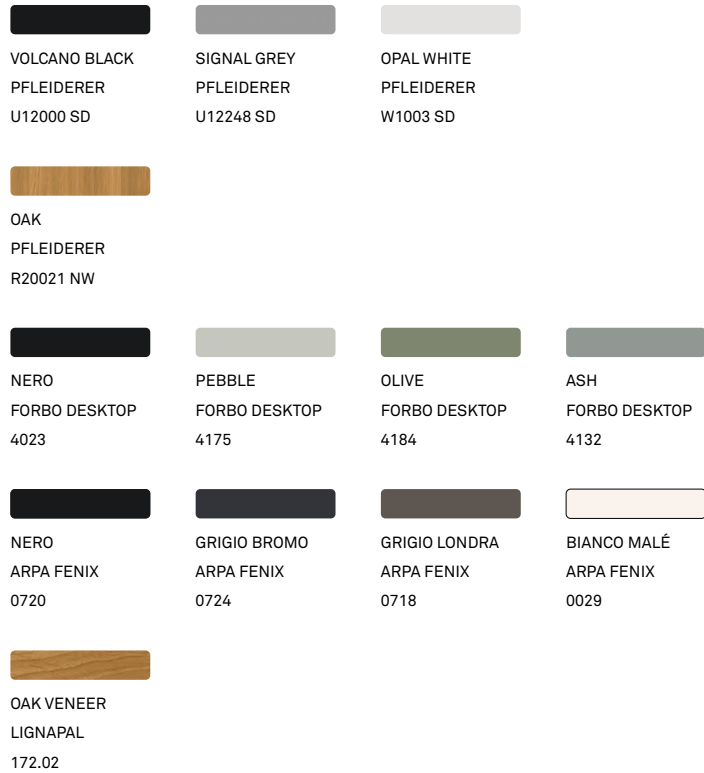

## METAL FINISHES

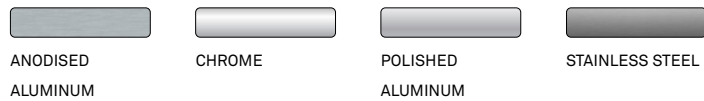

Contact our sales department for:

- Project samples
- Material samples
- Fabric sheets
- Owned fabrics
- Special colours and dimensions
- Price list
- Product catalogue
- Request for quotation
- Express delivery
- Conditions of sale and delivery

Visit our website for:

- 3D CAD data
- OFML data
- pCon Planner DWG files
- High Resolution images
- Product sheets
- Assembly instructions
- Maintenance instructions

Cascando Products b.v.  
Impact 2  
NL-6921 RZ Duiven  
The Netherlands

P +31(0)26 35 19 603  
I [www.cascando.com](http://www.cascando.com)  
E [design@cascando.nl](mailto:design@cascando.nl)

MEET US



## COLOURS



## WOOD COLOURS



Colours and materials can differ from image, for a true colour perspective, please use a RAL or NCS colour card.

## GENERAL INFORMATION



Cascando Products b.v.  
Impact 2  
NL-6921 RZ Duiven  
The Netherlands

P +31(0)26 35 19 603  
I [www.cascando.com](http://www.cascando.com)  
E [design@cascando.nl](mailto:design@cascando.nl)

MEET US

